

**TARIFF-FREE TABLES**

Proudly crafted in the USA.  
No tariff surcharge.

# Tables

## 2026 Price List

[➔ JUMP TO PRICING](#)

**VERSTEEL**



**Tops**

Eliga X base tables are available in round and square top shapes. Rectangle, racetrack, boatshape and arc boatshape top shapes are available with the E-series tables, and the End-Sit tables are standard with rectangle top shapes. The laminate and veneer tops in the Eliga series are 1" thick with square corners.

**Bases**

The X base is constructed of a single square tube upright with four Eliga shaped feet. The E-Series and End-Sit table bases feature a parallelogram tube construction. The round and square tops can be specified with fixed or tilt bases in either 29" standard table height or 42" stand-up table height. The standard table height for the E-series and End-Sit tables is 29". When End-Sit tables are configured in a group setting the angles of the legs permit comfortable "end-seating" by creating a cove where the user can nest.

**Modesty Panels**

The 24" and 30" wide tables with four post legs may be specified with or without a modesty panel. The rectangle sliding table has a fixed modesty panel.

**Features + Options**

Tables are standard with nylon adjustable glides except for slim-tilt tables which are standard with casters. Optional casters and table link are available where applicable. See individual pricing pages for additional available features such as fixed or slim tilt bases and sliding tops.

**Power + Data**

To complete your specification, power and data along with wire management options can be added to your table. Refer to the Power + Data Price List. All End-Sit bases feature an integrated wire manager in the leg.

**Whiteboard**

To complete your training room or collaborative environment an Eliga mobile whiteboard can be added to your specification. The whiteboard features dual-wheel locking casters, generous two-sided dry erase writing surface and a shelf on each side for marker and eraser storage. Whiteboard is available in all Versteel powder coat colors.

**Laminate and Veneer, Standard Core Construction**

The standard top construction consists of 45-50 lb particleboard, surfaced with a high pressure laminate or plain sliced veneer face. A backer sheet is laminated to the underside of the top. Tops are shipped pre-drilled for field installation of bases and accessories.



**PVC Flat Edge**

Edge of 2mm PVC hot melt banded to the top with 1/8" radius at the top and bottom. Available with 1 1/2" radius corners or square corners.

Offered in twenty-one (21) standard colors.



**Wood Flat Edge**

Wood banding hot melt banded to the top with 1/8" radius at the top and bottom. Available with 1 1/2" radius corners or square corners.



Offered in Ash, Cherry, Maple or Walnut materials.



**Wood Square Edge**

Edge of 1 1/4" wide solid wood with softened top and bottom edges, and square, softened mitered corners.



Offered in Ash, Cherry, Maple or Walnut materials.

**Shipping Schedule**

**Standard Items**

Laminate, PVC Edge	3-5 WEEKS
Laminate, Wood Edge	3-5 WEEKS
Veneer, Wood Edge	6-8 WEEKS

Contact Versteel Customer Service for special lead time requests.

**BIFMA**

All Versteel products are constructed to pass the relevant ANSI/BIFMA standards. For more detailed specifications by series and base style, contact Versteel Customer Service at 800.876.2120.

Additional information regarding warranty, terms and conditions, shipping, care and maintenance, etc. can be found in the All Tables price list.

**To Order, Specify...**

- 1 Model Number, include top and edge style
- 2 Top Material
  - a. Laminate manufacturer and color
  - b. Veneer species and finish color
- 3 Edge Color
- 4 Base Color
- 5 Additional Options

base model					finish selections			options		
<b>EG</b>	<b>TE</b>	<b>3072</b>	<b>RE</b>	<b>ST</b>	<b>LP7S</b>	<b>TP</b>	<b>WW160-SD</b>	<b>CPRC</b>	<b>ECHR</b>	<b>CAS55</b>
series	base style	top size	top shape	table function	top, edge & corner	top laminate manufacturer & laminate color	edge color	base color	base option	

An **EGTE 3072REST LP7S** is an Eliga series 30" x 72" rectangle table with slim-tilt end-sit bases, a laminate 1" thick top with a PVC edge and square corners.

The codes **TP WW160-SD / CPRC / ECHR** specify a Pionite WW160-SD Pralines & Cream laminate, Pralines & Cream PVC and Chrome bases.

The code **CAS55** specifies dual wheel black hard wheel casters.

**Model Number** **EGTE 3072REST LP7S**

**Orders may be sent via**
**Mailing Address**

Versteel  
 2332 Cathy Lane  
 Jasper IN 47546

**Contact Versteel**

**Email** contact@versteel.com  
**Phone** 800 876 2120  
 812 634 2120

**Laminate**

Versteel's standard offering of laminates includes over 900 laminates from Formica, Nevamar, Pionite and Wilsonart.

Laminate manufacturers change standard offerings frequently, making it possible a standard product can become unavailable. Versteel cannot be responsible for any inconvenience this may cause.

**Veneer**

Eliga tables are available with plain sliced Ash, Cherry, Maple and Walnut veneers.

**Veneer Species**

Ash . . . . .	AP01	Maple. . . . .	MP01
Cherry . . . . .	CP01	Walnut . . . . .	WP01

**Veneer Finish**

**Ash**

Beach. . . . .	VBEA	Fog . . . . .	VFOG
Chestnut. . . . .	VCHE	Pebble . . . . .	VPEB
Drift . . . . .	VDRI	Whisper . . . . .	VVWHI
Fawn . . . . .	VFAW		

**Cherry**

Blossom Cherry . . . . .	VBLC	Java Cherry. . . . .	VJAC
Cordovan Cherry . . . . .	VCNC	Millwork Cherry. . . . .	VMWC
Golden Cherry . . . . .	VGNC		

**Maple**

Caramel Maple . . . . .	VCMM	Sugar Maple . . . . .	VSUM
Solar Maple. . . . .	VSLM		

**Walnut**

Brighton Walnut . . . . .	VBRW	Natural Walnut. . . . .	VNAW
Espresso Walnut. . . . .	VESW		

**PVC Edge Colors**

Absolute Acajou . . . . .	CABA	Pearl . . . . .	CPEA
Alloy. . . . .	CALY	Platinum . . . . .	CPLA
Carbon. . . . .	CCAR	Pralines & Cream . . . . .	CPRC
Champagne . . . . .	CCHA	Shadow . . . . .	CSHA
Coconut . . . . .	CCOC	Snow . . . . .	CSNO
Ebony. . . . .	CEBO	Stone . . . . .	CSTO
Florence Walnut . . . . .	CFLW	Storm. . . . .	CSTM
Fossil . . . . .	CFOS	Whisper . . . . .	CVWHI
Graphite . . . . .	CGRA	White Linen . . . . .	CVHLL
Grey. . . . .	CGRE		
Kensington Maple. . . . .	CKEM		
Nimbus. . . . .	CNIM		

**Wood Edge Species**

Ash . . . . .	A01	Maple. . . . .	M01
Cherry . . . . .	C01	Walnut . . . . .	W01

**Wood Edge Finishes**

**Ash**

Beach. . . . .	WBEA	Fog . . . . .	WFOG
Chestnut. . . . .	WCHE	Pebble . . . . .	WPEB
Drift . . . . .	WDRI	Whisper . . . . .	WWHI
Fawn . . . . .	WFAW		

**Cherry**

Blossom Cherry . . . . .	WBLC	Java Cherry. . . . .	WJAC
Cordovan Cherry . . . . .	WCNC	Millwork Cherry. . . . .	WMWC
Golden Cherry . . . . .	WGNC		

**Maple**

Caramel Maple . . . . .	WCMM	Sugar Maple . . . . .	WSUM
Solar Maple. . . . .	WSLM		

**Walnut**

Brighton Walnut . . . . .	WBRW	Natural Walnut. . . . .	WNAW
Espresso Walnut. . . . .	WESW		

**Studio Steel®**

Versteel’s “urban fabrication” process leaves the telltale signs of welding and assembly on the surface, highlighting a manufacturing aesthetic. Choosing a clear or transparent powder coat is recommended, allowing tonal striations (created as a result of extreme heat), natural textures, and the inherent qualities of raw steel to show through.

Studio Steel Process . . . . . \$165

**Powder Coat Finishes**

All powder coat finishes in the Versteel offering have been formulated with the use of epoxy, polyester or epoxy and polyester blends to maximize the finish durability.

**Powder Coat Finish Options**

Powder Coat – Standard . . . . . n/c  
 Powder Coat – Premium (Hope). . . . . \$165  
 Powder Coat – Premium (Platinum) . . . . . \$488

**Powder Coat Colors**

Alloy. . . . .	.PALY	Mint . . . . .	.PMNT
Amethyst . . . . .	.PAME	Navy . . . . .	.PNAV
Anthracite . . . . .	.PANT	Nimbus. . . . .	.PNIM
Black Anodized. . . . .	.PBLA	Nutmeg . . . . .	.PNUT
Bronze . . . . .	.PBRO	◆ Pacific . . . . .	.PPAC
Calypso . . . . .	.PCAL	Pearl . . . . .	.PPEA
Carbon. . . . .	.PCAR	Pebble . . . . .	.PPEB
Champagne . . . . .	.PCHA	Ⓟ Platinum . . . . .	.PPLA
Coconut . . . . .	.PCOC	Poppy. . . . .	.PPOP
◆ Copper. . . . .	.PCOP	◆ Raven. . . . .	.PRAV
Crimson . . . . .	.PCRI	Royal . . . . .	.PROY
◆ Crystal . . . . .	.PCRY	Seaside . . . . .	.PSEA
Daffodil. . . . .	.PDAF	Shipyards . . . . .	.PSHI
Ebony. . . . .	.PEBO	Silver . . . . .	.PSIL
Forest. . . . .	.PFOR	Snow . . . . .	.PSNO
Fossil . . . . .	.PFOS	Stone . . . . .	.PSTO
◆ Garnet . . . . .	.PGAR	Storm. . . . .	.PSTM
◆ Gold. . . . .	.PGOL	Terra Cotta . . . . .	.PTEC
Graphite . . . . .	.PGRA	Whisper . . . . .	.PWHI
Ⓟ Hope . . . . .	.PHOP	White Linen . . . . .	.PWHL
Kelly Green . . . . .	.PKEG	Powder Coat Alternative . . . . .	.OPA
◆ Matte . . . . .	.PMAT		
Mica. . . . .	.PMIC		

**Transparent Powder Coats (indicated by ◆)**

Please note that the transparent characteristics of these powders allow all natural welds and textures inherent to raw steel to be visible. Transparent powder coat available on Eliga upon sample approval.

**Premium Powder Coats (indicated by Ⓟ)**

Versteel’s premium process uses specially formulated powder coats for a truly unique color palette.

**Chrome**

Versteel applies a deep luster chrome plated finish. Chrome is the most durable finish available. Specify Chrome and add \$649 list per table.

Chrome . . . . . ECHR

**Nickel**

Versteel applies a nickel plated finish with a clear coat applied for durability. Specify Nickel and add \$710 list per table.

Nickel . . . . . ENKL

**NOTE** CHROME AND NICKEL ARE NOT AVAILABLE ON THE ELIGA WHITEBOARD

**Finish Reference & Samples**

For finish color reference, please refer to our website. Contact Versteel Customer Service to receive actual color samples for color matches and final color approval.

**Special Laminate**

**Call for quotation**

Specify code **TSP** (*Special Laminate*), indicate the quoted charges per table

Special laminates and patterns can be specified as an option. To specify, contact Versteel Customer Service for availability and pricing.

**NOTE** LAMINATES IN STANDARD COLORS AND TEXTURES FROM FORMICA, NEVAMAR, PIONITE AND WILSONART ARE STANDARD

**CAUTION** LAMINATE MANUFACTURERS CHANGE STANDARD OFFERINGS FREQUENTLY, MAKING IT POSSIBLE A STANDARD PRODUCT CAN BECOME UNAVAILABLE. VERSTEEL CANNOT BE RESPONSIBLE FOR ANY INCONVENIENCE THIS MAY CAUSE.

**Custom PVC Color Match**

**Call for quotation / one time charge per color, per order**

Specify code **OCF** (*Custom PVC Color Match*), add cost from Versteel quotation

PVC Color Match can be the selection of a color that is available from a Versteel supplier or a new custom color developed for the order. Minimum footage requirements mean that the amount of material needed for your order will effect the cost.

For PVC Color Matching you must supply a color reference sample. Versteel will review the sample for possible existing colors available and send a sample for customer approval. If no color match exists, a custom match will be developed and sampled for customer approval before a production schedule is established.

**Powder Coat Alternative**

**Call for quotation**

Specify code **OPA** (*Powder Coat Alternative*), add cost from Versteel quotation

Powder Coat Alternative is available from Versteel. The entire RAL color reference along with hundreds of other color and finishes are available.

For Powder Coat Alternative matching, you must supply a color reference sample, or an RAL number. Versteel will review the sample for possible existing colors available and send a sample for customer approval. If no color match exists a custom match can be developed. Call Versteel Customer Service for associated upcharges on custom color development.

**Stain Finish Match**

**\$996 / one time charge per finish, per order**

Specify code **OSM** (*Stain Finish Match*), add \$996.00 list per finish, per order

Alternative Stain Finishes are available for veneer and wood edged tops.

For Stain Finish Matching you must supply two 4" x 4" finish color and grain reference samples. An expertly finish matched sample will be provided for customer approval.

**Veneer and Wood Edge Alternatives**

**Call for quotation**

For veneer and wood edge requirements other than the standard plain sliced Ash, Cherry, Maple and Walnut, contact Versteel Customer Service. Versteel is adept at working with a host of domestic and exotic materials. From inlays, figures, pie cuts and special edge profiles, to custom fill levels and sheens, each top is created using the best of technology and old world craftsmanship. The items you only imagined or expected to only be available from a millwork shop are now just another part of your Versteel order. Call Versteel Customer Service for availability and quotation.

**Wood Finish Alternatives**

**Call for quotation**

When veneer tables are required to have a finish other than the standard natural grain fill level finish appearance, semi-filled or full-filled finishes are available by requesting a quote from Versteel. Call Versteel Customer Service for availability and quotation.

**Table Top and Edge Alternatives**

Table tops and/or edges can be produced in alternative materials if desired. Contact Versteel Customer Service for pricing and availability.

**Alternate Core Construction**

Alternate core constructions are available, including medium density fiberboard (MDF), and cores that contain no urea formaldehyde. Contact Versteel Customer Service for pricing and availability.

**NOTE** CUSTOMS OR ALTERNATIVES MAY AFFECT STANDARD PRODUCTION SCHEDULES

**Alternate Table Height 32" and Under****\$196 / table**

Specify code **BAH** (*Alternate Height 32" and under*), indicate desired table height (32" or less), add \$196.00 list per table

Suggested typing height table is 26 ¾"

Suggested wheelchair height table is 32"

Suggested stand up height table is 42"

**NOTE** FOR OTHER TABLE HEIGHT REQUIREMENTS CONTACT VERSTEEL CUSTOMER SERVICE FOR STRUCTURAL DETAILS, PRICING AND AVAILABILITY

**NOTE** NOT ALL ELIGA TABLES ARE AVAILABLE WITH AN ALTERNATE TABLE HEIGHT. REFER TO PRICING PAGES OR CONTACT VERSTEEL CUSTOMER SERVICE.

**Casters - Dual Hard Wheel Black Hard or Soft****\$171 / table**

Specify code **CAS55** (Hard Wheel) or **CAS57** (Soft Wheel), add \$171.00 list per table

Dual wheel, black, 2" diameter, standard locking casters are available on X1 and TE base styles. Each is fitted into a reinforced caster receiver and must be specified at time of order. Caster option does not change the overall height of the table. See individual product pages for availability and ordering code.

**Mix - Dual Hard Wheel Casters & Glides****\$163 / table**

Specify code **BMD** (*Mix - Dual Hard Wheel Casters & Glides*), add \$163.00 list per table

Tables with TE bases can be specified with dual hard wheel, black, 2" diameter, standard locking casters on half of the table, with glides on the other half. Each caster is fitted into a reinforced receiver and must be specified at time of order. Mix option does not change the overall height of the table.

**Casters - Dual Wheel Black Hard****\$171 / table**

Specify code **CAS50** (Hard Wheel), add \$171.00 list per table

Dual wheel, black, 2.15" diameter, standard locking casters are available on E1 and E2 base styles. Each is fitted into a reinforced caster receiver and must be specified at time of order. Caster option does not change the overall height of the table. See individual product pages for availability and ordering code.

**Self-Leveling Glides****\$49 / table**

Specify code **GLD04** (*Self-Leveling Glides*), add \$49.00 list per table

Self-Leveling Glides replace standard glides. This option allows the table to automatically compensate up to ½" for floors that are not level. Self-leveling glides increase overall table height by ¾". See individual product pages for availability.



**Top Custom Cutout**

**\$120 / cutout**

Specify code **TCC** (Top Custom Cutout), add \$120.00 list per cutout

Top Custom Cutout requires a drawing for production and is subject to approvals.

**Table Link**

**\$251 / table**

Specify code **TLK** (Table Link), add \$251.00 list per table

Table Link is for linking Versteel table configurations in typical room situations. Table link will prevent the accidental disconnection of power supply to adjacent tables. Available on tables with PVC, 3mm Wood, Wood Square, Wood Fluted and Ergo user side edge details.



Closed end link brackets are provided for tops without bases or tables with a base that does not allow the table to stand alone.



**Table Link - Ends Only**

**\$135 / table**

Specify code **TLE** (Table Link - Ends Only), add \$135.00 list per table







Table Link is for linking Versteel table configurations in typical room situations. Specify Table Link - Ends Only when your configuration requires linking on the table ends only. Available on tables with PVC, 3mm Wood, Wood Square, Wood Fluted and Ergo user side edge details. Table Link - Ends Only is included with electrical package options. This will prevent the accidental disconnection of power supply to adjacent tables.





**Questions?**

800 876 2120

Base Style	Table Description	Model #	Product Wt	top >	Laminate	Laminate	Laminate	Veneer	Veneer
				edge >	PVC	Wood	1 1/4" Wood	Wood	1 1/4" Wood
					Flat	Flat	Square	Flat	Square
				edge ordering code >	 <b>LP7R</b>	 <b>LW7R</b>	 <b>LWS7</b>	 <b>VW7R</b>	 <b>VWS7</b>
				top thickness >	1"	1"	1"	1"	1"
				top thickness price >	1"	1"	1"	1"	1"
 XI	24 Fix	<b>EGXI 24RDFX</b>	30	992	1363	1736	2066	2206	
	30 Fix	<b>EGXI 30RDFX</b>	35	1135	1603	2069	2428	2555	
	36 Fix	<b>EGXI 36RDFX</b>	44	1310	1869	2428	2570	2752	
	42 Fix	<b>EGXI 42RDFX</b>	53	1562	2209	2860	3111	3344	
	48 Fix	<b>EGXI 48RDFX</b>	64	1590	2337	3081	3637	3924	
 XIS	24 Stand Fix	<b>EGXIS 24RDFX</b>	37	1028	1399	1774	2102	2244	
	30 Stand Fix	<b>EGXIS 30RDFX</b>	44	1166	1633	2098	2459	2633	
	36 Stand Fix	<b>EGXIS 36RDFX</b>	52	1341	1900	2459	2602	2782	
	42 Stand Fix	<b>EGXIS 42RDFX</b>	62	1589	2239	2892	3140	3372	
	48 Stand Fix	<b>EGXIS 48RDFX</b>	73	1620	2365	3110	3675	3955	

**Note:** Eliga X bases with power and data ship with modified top plates. Contact Versteel Customer Service for application specifics.

**Note:** Casters not available on stand up height.

**To Order, Specify...**

- 1 Model Number
- 2 Top Material
- 3 Edge Style and Thickness
- 4 Edge Color
- 5 Base Color
- 6 Additional Options



**Base Options**

	<b>Code</b>	<b>Price</b>
Casters (4), Dual Wheel Black Hard Wheel .....	.CAS55	\$ 171
Casters (4), Dual Wheel Black Soft Wheel .....		
Available on X1 base .....	.CAS57	\$ 171
Self-Leveling Glides (4) .....	.GLD04	\$ 49

**Finish Options**

Chrome .....	\$ 649
Nickel .....	\$ 710
Powder Coat, Standard .....	n/c
Powder Coat, Premium .....	\$ 165
Platinum .....	\$ 488
<small>Transparent Powder Coat available by sample approval</small>	

**Top Options**

Special Laminate .....	TSP	call
Custom Cutout (per cutout) .....	TCC	\$ 120

**Power + Data Options**

Please reference the Power + Data Price List

**NOTE** NODE IS RECOMMENDED FOR USE WITH ELIGA X BASES

**Wire Management Options**

1 Round Grommet, Provide Location Print .....	WRG	\$ 76
---	-----	-------



**Questions?**  
800 876 2120

		top > edge >	Laminate PVC	Laminate Wood	Laminate 1 1/4" Wood	Veneer Wood	Veneer 1 1/4" Wood	
			Flat	Flat	Square	Flat	Square	
		edge ordering code (square corner) > top thickness >	<b>LP7S</b> 1"	<b>LW7S</b> 1"	<b>LWS7</b> 1"	<b>VW7S</b> 1"	<b>VWS7</b> 1"	
		top thickness price >	1"	1"	1"	1"	1"	
 X1	24 Fix	<b>EGX1 24SQFX</b>	33	992	1363	1736	2066	2206
	30 Fix	<b>EGX1 30SQFX</b>	40	1135	1603	2069	2428	2555
	36 Fix	<b>EGX1 36SQFX</b>	50	1310	1869	2428	2570	2752
	42 Fix	<b>EGX1 42SQFX</b>	60	1562	2209	2860	3111	3344
	48 Fix	<b>EGX1 48SQFX</b>	75	1590	2337	3081	3637	3924
 XIS	24 Stand Fix	<b>EGXIS 24SQFX</b>	40	1028	1399	1774	2102	2244
	30 Stand Fix	<b>EGXIS 30SQFX</b>	49	1166	1633	2098	2459	2633
	36 Stand Fix	<b>EGXIS 36SQFX</b>	58	1341	1900	2459	2602	2782
	42 Stand Fix	<b>EGXIS 42SQFX</b>	69	1589	2239	2892	3140	3372
	48 Stand Fix	<b>EGXIS 48SQFX</b>	84	1620	2365	3110	3675	3955

**Note:** Eliga X bases with power and data ship with modified top plates. Contact Versteel Customer Service for application specifics.

**Note:** Casters not available on stand up height.

**To Order, Specify...**

- 1 Model Number
- 2 Top Material
- 3 Edge Style and Thickness
- 4 Edge Color
- 5 Base Color
- 6 Additional Options



<b>Base Options</b>	<b>Code</b>	<b>Price</b>
Casters (4), Dual Wheel Black Hard Wheel .....	.CAS55	\$ 171
Casters (4), Dual Wheel Black Soft Wheel .....		
Available on X1 base .....	.CAS57	\$ 171
Self-Leveling Glides (4) .....	.GLD04	\$ 49

<b>Finish Options</b>		
Chrome .....		\$ 649
Nickel .....		\$ 710
Powder Coat, Standard .....		n/c
Powder Coat, Premium .....		\$ 165
Platinum .....		\$ 488
<small>Transparent Powder Coat available by sample approval</small>		

<b>Top Options</b>		
Special Laminate .....	TSP	call
Custom Cutout (per cutout) .....	TCC	\$ 120

**Power + Data Options**  
Please reference the Power + Data Price List

**NOTE** NODE IS RECOMMENDED FOR USE WITH ELIGA X BASES

<b>Wire Management Options</b>		
1 Round Grommet, Provide Location Print .....	WRG	\$ 76





**Base Options**

	<b>Code</b>	<b>Price</b>
Alternate Table Height 32" & Under.....	BAH	\$ 196
Alternate Table Height 32" & Over.....	BSP	call
Casters (4), Dual Wheel Black		
Hard Wheel (to 72" length).....	CAS50	\$ 171

**Finish Options**

Chrome .....	\$ 649
Nickel.....	\$ 710
Powder Coat, Standard .....	n/c
Powder Coat, Premium.....	\$ 165
Platinum.....	\$ 488
<small>Transparent Powder Coat available by sample approval</small>	

**Top Options**

Table Link (all four sides) .....	TLK	\$ 251
Table Link (18" ends only) .....	TLE	\$ 135
Special Laminate.....	TSP	call
Custom Cutout (per cutout) .....	TCC	\$ 120

**Power + Data Options**





Please reference the Power + Data Price List

**Wire Management Options**

1 Oval Brush Grommet, Provide Location Print.....	WOG	\$ 97
1 Round Grommet, Provide Location Print .....	WRG	\$ 76
Eliga Wire Manager (each).....	WEL	\$ 56



**Questions?**  
800 876 2120

top > edge >	Laminate PVC	Laminate Wood	Laminate 1 1/2" Wood	Veneer Wood	Veneer 1 1/2" Wood
	Flat	Flat	Square	Flat	Square
					
edge ordering code (square corner) > top thickness >	<b>LP7S</b> 1"	<b>LW7S</b> 1"	<b>LWS7</b> 1"	<b>VW7S</b> 1"	<b>VWS7</b> 1"
top thickness price >	1"	1"	1"	1"	1"

Base Style	Table Description	Model #	Product Wt	1"	1"	1"	1"	1"	
EI	24 x 48 Fix	<b>EGE1 2448REFX</b>	55	1360	1939	2520	2541	2712	
	24 x 48 Fix w/FixMod	<b>EGE1 2448REFX XM</b>	70	1763	2344	2923	2944	3115	
	24 x 60 Fix	<b>EGE1 2460REFX</b>	66	1547	2225	2903	3109	3335	
	24 x 60 Fix w/FixMod	<b>EGE1 2460REFX XM</b>	81	1949	2626	3307	3512	3740	
	24 x 72 Fix	<b>EGE1 2472REFX</b>	77	1668	2441	3217	3497	3757	
	24 x 72 Fix w/FixMod	<b>EGE1 2472REFX XM</b>	92	2073	2848	3622	3900	4162	
	24 x 84 Fix	<b>EGE1 2484REFX</b>	88	1928	2798	3670	3862	4160	
	24 x 84 Fix w/FixMod	<b>EGE1 2484REFX XM</b>	103	2493	3363	4234	4428	4725	
	24 x 96 Fix	<b>EGE1 2496REFX</b>	99	1985	2953	3920	4276	4612	
	24 x 96 Fix w/FixMod	<b>EGE1 2496REFX XM</b>	114	2550	3517	4485	4841	5177	

- To Order, Specify...**
- 1 Model Number
  - 2 Top Material
  - 3 Edge Style and Thickness
  - 4 Edge Color
  - 5 Base Color
  - 6 Additional Options



**Base Options**

	<b>Code</b>	<b>Price</b>
Alternate Table Height 32" & Under.....	BAH	\$ 196
Alternate Table Height 32" & Over.....	BSP	call
Casters (4), Dual Wheel Black		
Hard Wheel (to 72" length).....	CAS50	\$ 171

**Finish Options**

Chrome .....	\$ 649
Nickel.....	\$ 710
Powder Coat, Standard .....	n/c
Powder Coat, Premium.....	\$ 165
Platinum.....	\$ 488
<small>Transparent Powder Coat available by sample approval</small>	

**Top Options**

Table Link (all four sides) .....	TLK	\$ 251
Table Link (24" ends only).....	TLE	\$ 135
Special Laminate.....	TSP	call
Custom Cutout (per cutout) .....	TCC	\$ 120

**Power + Data Options**

Please reference the Power + Data Price List

**Wire Management Options**

1 Oval Brush Grommet, Provide Location Print.....	WOG	\$ 97
1 Round Grommet, Provide Location Print .....	WRG	\$ 76
Eliga Wire Manager (each).....	WEL	\$ 56





**Base Options**

	<b>Code</b>	<b>Price</b>
Alternate Table Height 32" & Under.....	BAH	\$ 196
Alternate Table Height 32" & Over.....	BSP	call
Casters (4), Dual Wheel Black		
Hard Wheel (to 72" length).....	CAS50	\$ 171

**Finish Options**

Chrome .....	\$	649
Nickel.....	\$	710
Powder Coat, Standard .....		n/c
Powder Coat, Premium.....	\$	165
Platinum.....	\$	488
<small>Transparent Powder Coat available by sample approval</small>		

**Top Options**

Table Link (all four sides) .....	TLK	\$ 251
Table Link (30" ends only) .....	TLE	\$ 135
Special Laminate.....	TSP	call
Custom Cutout (per cutout) .....	TCC	\$ 120

**Power + Data Options**

Please reference the Power + Data Price List

**Wire Management Options**

1 Oval Brush Grommet, Provide Location Print.....	WOG	\$ 97
1 Round Grommet, Provide Location Print .....	WRG	\$ 76
Eliga Wire Manager (each).....	WEL	\$ 56





**Base Options**

**Code Price**

Casters (4), Dual Wheel Black		
Hard Wheel (to 72" length).....	CAS50	\$ 171

**Finish Options**

Chrome .....		\$ 649
Nickel.....		\$ 710
Powder Coat, Standard .....		n/c
Powder Coat, Premium.....		\$ 165
Platinum.....		\$ 488

Transparent Powder Coat available by sample approval

**Top Options**

Table Link (24" ends only).....	TLE	\$ 135
Special Laminate.....	TSP	call
Custom Cutout (per cutout) .....	TCC	\$ 120

**Power + Data Options**

Eliga Power (specify location)		
located in frame, not on table top (each) .....	EGI	\$ 488
Power Infeed (each).....	HNPU	\$ 450

**Wire Management Options**

Eliga Wire Manager (each).....	WEL	\$ 56
--------------------------------	-----	-------







**Questions?**

800 876 2120

top >  
edge >

edge ordering code (square corner) >  
top thickness >

	Laminate PVC	Laminate Wood	Laminate 1 1/4" Wood	Veneer Wood	Veneer 1 1/4" Wood			
	Flat	Flat	Square	Flat	Square			
								
	<b>LP7S</b> 1"	<b>LW7S</b> 1"	<b>LWS7</b> 1"	<b>VW7S</b> 1"	<b>VWS7</b> 1"			
	1"	1"	1"	1"	1"			
<b>Base Style</b>	<b>Table Description</b>	<b>Model #</b>	<b>Product Wt</b>					
E6S	42 x 72 Fix	<b>EGE6S 4272REFX</b>	138	3088	3972	4856	5972	6395
E5S	42 x 84 Fix	<b>EGE5S 4284REFX</b>	213	3552	4530	5506	6581	7058
E6S/E5S Standard Height (42")	42 x 96 Fix	<b>EGE5S 4296REFX</b>	233	3622	4693	5762	7238	7780
	48 x 60 Fix	<b>EGE5S 4860REFX</b>	172	2517	3354	4192	5339	5733
	48 x 72 Fix	<b>EGE5S 4872REFX</b>	194	2796	3727	4654	6123	6590
	48 x 84 Fix	<b>EGE5S 4884REFX</b>	216	3217	4243	5266	6798	7336
	48 x 96 Fix	<b>EGE5S 4896REFX</b>	252	3665	4782	5896	7895	8504
	48 x 120 Fix	<b>EGE5S 48120REFX</b>	366	5668	6972	8276	12227	13101
	48 x 144 Fix	<b>EGE5S 48144REFX</b>	422	6216	7704	9192	14576	15680
	48 x 192 Fix	<b>EGE5S 48192REFX</b>	515	7201	9060	10924	17462	18840
	60 x 72 Fix	<b>EGE5S 6072REFX</b>	229	3276	4448	5865	7464	8054
	60 x 84 Fix	<b>EGE5S 6084REFX</b>	251	3704	4937	6606	8013	8658
	60 x 96 Fix	<b>EGE5S 6096REFX</b>	273	3798	5138	6341	8876	9604
	60 x 120 Fix	<b>EGE5S 60120REFX</b>	411	5948	7344	8740	13596	14606
	60 x 144 Fix	<b>EGE5S 60144REFX</b>	475	6575	8158	9738	16539	17836
	60 x 192 Fix	<b>EGE5S 60192REFX</b>	584	7672	9627	11581	20092	21731
	60 x 240 Fix	<b>EGE5S 60240REFX</b>	685	9181	11506	13832	23951	25899

**To Order, Specify...**

- 1 Model Number
- 2 Top Material
- 3 Edge Style and Thickness
- 4 Edge Color
- 5 Base Color
- 6 Additional Options



**Finish Options**

	<b>Code</b>	<b>Price</b>
Chrome .....		\$ 649
Nickel .....		\$ 710
Powder Coat, Standard .....		n/c
Powder Coat, Premium .....		\$ 165
Platinum .....		\$ 488

Transparent Powder Coat available by sample approval

**Top Options**

Special Laminate .....	TSP	call
Custom Cutout (per cutout) .....	TCC	\$ 120

**Power + Data Options**

Please reference the Power + Data Price List

**Wire Management Options**

1 Oval Brush Grommet, Provide Location Print .....	WOG	\$ 97
1 Round Grommet, Provide Location Print .....	WRG	\$ 76
Eliga Wire Manager (each) .....	WEL	\$ 56



**Questions?**

800 876 2120

top >	Laminate PVC	Laminate Wood	Laminate 1 1/4" Wood	Veneer Wood	Veneer 1 1/4" Wood
edge >	Flat	Flat	Square	Flat	Square
edge ordering code >	<b>LP7R</b>	<b>LW7R</b>	<b>LWS7</b>	<b>VW7R</b>	<b>VWS7</b>
top thickness >	1"	1"	1"	1"	1"
top thickness price >	1"	1"	1"	1"	1"

Base Style	Table Description	Model #	Product Wt	1"	1"	1"	1"	1"
E5S Standard Height (42")	42 x 84 Fix	<b>EGE5S 4284RAFX</b>	175	3913	4888	5868	6748	7244
	42 x 96 Fix	<b>EGE5S 4296RAFX</b>	192	4000	5069	6141	7394	7951
	48 x 96 Fix	<b>EGE5S 4896RAFX</b>	221	4050	5166	6283	8088	8717
	48 x 120 Fix	<b>EGE5S 48120RAFX</b>	266	6141	7442	8747	12431	13325
	48 x 144 Fix	<b>EGE5S 48144RAFX</b>	390	6803	8291	9783	14901	16035
	60 x 144 Fix	<b>EGE5S 60144RAFX</b>	434	7233	8816	10395	16562	17859
	60 x 192 Fix	<b>EGE5S 60192RAFX</b>	540	8472	10425	12381	20092	21731
	60 x 240 Fix	<b>EGE5S 60240RAFX</b>	643	10131	12457	14782	24075	26034

**To Order, Specify...**

- 1 Model Number
- 2 Top Material
- 3 Edge Style and Thickness
- 4 Edge Color
- 5 Base Color
- 6 Additional Options



**Finish Options**

	<b>Code</b>	<b>Price</b>
Chrome .....		\$ 649
Nickel .....		\$ 710
Powder Coat, Standard .....		n/c
Powder Coat, Premium .....		\$ 165
Platinum .....		\$ 488

Transparent Powder Coat available by sample approval

**Top Options**

Special Laminate .....	<b>TSP</b>	call
Custom Cutout (per cutout) .....	<b>TCC</b>	\$ 120

**Power + Data Options**

Please reference the Power + Data Price List

**Wire Management Options**

1 Oval Brush Grommet, Provide Location Print .....	<b>WOG</b>	\$ 97
1 Round Grommet, Provide Location Print .....	<b>WRG</b>	\$ 76
Eliga Wire Manager (each) .....	<b>WEL</b>	\$ 56



**Questions?**

800 876 2120

top >  
edge >

edge ordering code (square corner) >  
top thickness >

top thickness price >  
Product Wt





**Base Style**

**Table Description**

**Model #**

**Product Wt**

E5S  
Standard Height (42")

Laminate PVC	Laminate Wood	Laminate 1 1/4" Wood	Veneer Wood	Veneer 1 1/4" Wood			
Flat 	Flat 	Square 	Flat 	Square 			
<b>LP7S</b> 1"	<b>LW7S</b> 1"	<b>LWS7</b> 1"	<b>VW7S</b> 1"	<b>VWS7</b> 1"			
1"	1"	1"	1"	1"			
<b>Boat</b>							
42 x 48 x 96 Fix	<b>EGE5S 4296BTFX</b>	242	3869	4917	5959	7624	8214
42 x 48 x 120 Fix	<b>EGE5S 42120BTFX</b>	364	5836	7053	8273	11721	12566
42 x 48 x 144 Fix	<b>EGE5S 42144BTFX</b>	409	6486	7878	9269	13912	14973
48 x 60 x 192 Fix	<b>EGE5S 48192BTFX</b>	557	8283	10108	11938	16894	18238
48 x 60 x 240 Fix	<b>EGE5S 48240BTFX</b>	652	9902	12076	14250	23213	25112
<b>Arc Boat</b>							
42 x 48 x 96 Fix	<b>EGE5S 4296ABFX</b>	239	3869	4917	5959	7617	8208
42 x 48 x 120 Fix	<b>EGE5S 42120ABFX</b>	349	5836	7053	8273	11541	12369
42 x 48 x 144 Fix	<b>EGE5S 42144ABFX</b>	404	6486	7878	9269	13641	14673
48 x 60 x 192 Fix	<b>EGE5S 48192ABFX</b>	543	8283	10108	11938	19009	20564
48 x 60 x 240 Fix	<b>EGE5S 48240ABFX</b>	647	9902	12076	14250	22858	24725

**To Order, Specify...**

- 1 Model Number
- 2 Top Material
- 3 Edge Style and Thickness
- 4 Edge Color
- 5 Base Color
- 6 Additional Options



**Finish Options**

	<b>Code</b>	<b>Price</b>
Chrome .....		\$ 649
Nickel .....		\$ 710
Powder Coat, Standard .....		n/c
Powder Coat, Premium .....		\$ 165
Platinum .....		\$ 488

Transparent Powder Coat available by sample approval

**Top Options**

Special Laminate .....	<b>TSP</b>	call
Custom Cutout (per cutout) .....	<b>TCC</b>	\$ 120

**Power + Data Options**

Please reference the Power + Data Price List

**Wire Management Options**

1 Oval Brush Grommet, Provide Location Print .....	<b>WOG</b>	\$ 97
1 Round Grommet, Provide Location Print .....	<b>WRG</b>	\$ 76
Eliga Wire Manager (each) .....	<b>WEL</b>	\$ 56







**Questions?**

800 876 2120

top >  
edge >

edge ordering code (square corner) >  
top thickness >

	Laminate PVC	Laminate Wood	Laminate 1 1/4" Wood	Veneer Wood	Veneer 1 1/4" Wood			
	Flat 	Flat 	Square 	Flat 	Square 			
	<b>LP7S</b> 1"	<b>LW7S</b> 1"	<b>LWS7</b> 1"	<b>VW7S</b> 1"	<b>VWS7</b> 1"			
	1"	1"	1"	1"	1"			
<b>Base Style</b>								
<b>Table Description</b>								
<b>Model #</b>								
<b>Product Wt</b>								
E6	42 x 72 Fix	<b>EGE6 4272REFX</b>	128	3001	3886	4768	5887	6307
E5 E6/E5 Standard Height (29")	42 x 84 Fix	<b>EGE5 4284REFX</b>	203	3468	4444	5420	6493	6973
	42 x 96 Fix	<b>EGE5 4296REFX</b>	242	3536	4605	5676	7152	7693
	48 x 96 Fix	<b>EGE5 4896REFX</b>	252	3577	4696	5811	7809	8418
	48 x 120 Fix	<b>EGE5 48120REFX</b>	346	5456	6760	8063	12014	12888
	48 x 144 Fix	<b>EGE5 48144REFX</b>	402	6077	7568	9056	14442	15543
	48 x 192 Fix	<b>EGE5 48192REFX</b>	495	6966	8827	10688	17227	18603
	60 x 120 Fix	<b>EGE5 60120REFX</b>	391	5911	7306	8702	13560	14570
	60 x 144 Fix	<b>EGE5 60144REFX</b>	455	6539	8121	9703	16500	17798
	60 x 192 Fix	<b>EGE5 60192REFX</b>	564	7561	9514	11470	19981	21620
	60 x 240 Fix	<b>EGE5 60240REFX</b>	665	9091	11419	13745	23863	25810

**To Order, Specify...**

- 1 Model Number
- 2 Top Material
- 3 Edge Style and Thickness
- 4 Edge Color
- 5 Base Color
- 6 Additional Options



**Finish Options**

**Code Price**

Chrome .....		\$ 649
Nickel .....		\$ 710
Powder Coat, Standard .....		n/c
Powder Coat, Premium .....		\$ 165
Platinum .....		\$ 488

Transparent Powder Coat available by sample approval

**Top Options**

Special Laminate .....	TSP	call
Custom Cutout (per cutout) .....	TCC	\$ 120

**Power + Data Options**

Please reference the Power + Data Price List

**Wire Management Options**

1 Oval Brush Grommet, Provide Location Print .....	WOG	\$ 97
1 Round Grommet, Provide Location Print .....	WRG	\$ 76
Eliga Wire Manager (each) .....	WEL	\$ 56



**Questions?**  
800 876 2120

top > edge >	Laminate PVC	Laminate Wood	Laminate 1 1/4" Wood	Veneer Wood	Veneer 1 1/4" Wood
	Flat	Flat	Square	Flat	Square
edge ordering code >	<b>LP7R</b>	<b>LW7R</b>	<b>LWS7</b>	<b>VW7R</b>	<b>VWS7</b>
top thickness >	1"	1"	1"	1"	1"
top thickness price >	1"	1"	1"	1"	1"

Base Style	Table Description	Model #	Product Wt	1"	1"	1"	1"	1"
E5 Standard Height (29')	42 x 84 Fix	<b>EGE5 4284RAFX</b>	165	3827	4803	5780	6663	7157
	42 x 96 Fix	<b>EGE5 4296RAFX</b>	182	3913	4984	6051	7306	7864
	48 x 96 Fix	<b>EGE5 4896RAFX</b>	211	3963	5080	6195	8002	8627
	48 x 120 Fix	<b>EGE5 48120RAFX</b>	256	6051	7355	8658	12345	13237
	48 x 144 Fix	<b>EGE5 48144RAFX</b>	370	6693	8181	9671	14788	15923

**To Order, Specify...**

- 1 Model Number
- 2 Top Material
- 3 Edge Style and Thickness
- 4 Edge Color
- 5 Base Color
- 6 Additional Options



**Finish Options**

	<b>Code</b>	<b>Price</b>
Chrome .....		\$ 649
Nickel .....		\$ 710
Powder Coat, Standard .....		n/c
Powder Coat, Premium .....		\$ 165
Platinum .....		\$ 488

Transparent Powder Coat available by sample approval

**Top Options**

Special Laminate .....	TSP	call
Custom Cutout (per cutout) .....	TCC	\$ 120

**Power + Data Options**

Please reference the Power + Data Price List

**Wire Management Options**

1 Oval Brush Grommet, Provide Location Print .....	WOG	\$ 97
1 Round Grommet, Provide Location Print .....	WRG	\$ 76
Eliga Wire Manager (each) .....	WEL	\$ 56



**Questions?**  
800 876 2120

top >  
edge >

edge ordering code (square corner) >  
top thickness >

top thickness price >  
Product Wt

**Base Style**

**Table Description**

**Model #**

**Product Wt**





E5  
Standard Height (29")

**Boat**

42 x 48 x 96 Fix	<b>EGE5 4296BTFX</b>	233
42 x 48 x 120 Fix	<b>EGE5 42120BTFX</b>	334
42 x 48 x 144 Fix	<b>EGE5 42144BTFX</b>	389
48 x 60 x 192 Fix	<b>EGE5 48192BTFX</b>	537
48 x 60 x 240 Fix	<b>EGE5 48240BTFX</b>	632

**Arc Boat**

42 x 48 x 96 Fix	<b>EGE5 4296ABFX</b>	229
42 x 48 x 120 Fix	<b>EGE5 42120ABFX</b>	329
42 x 48 x 144 Fix	<b>EGE5 42144ABFX</b>	384
48 x 60 x 192 Fix	<b>EGE5 48192ABFX</b>	523
48 x 60 x 240 Fix	<b>EGE5 48240ABFX</b>	627

Laminate PVC	Laminate Wood	Laminate 1 1/4" Wood	Veneer Wood	Veneer 1 1/4" Wood
Flat 	Flat 	Square 	Flat 	Square 
<b>LP7S</b> 1"	<b>LW7S</b> 1"	<b>LWS7</b> 1"	<b>VW7S</b> 1"	<b>VWS7</b> 1"
1"	1"	1"	1"	1"
4055	5173	6290	8070	8702
6158	7462	8765	12457	13360
6828	8317	9807	14777	15909
8752	10705	12660	17965	19402
10507	12835	15161	24750	26784
4055	5173	6290	8063	8698
6158	7462	8765	12264	13147
6828	8317	9807	14486	15588
8752	10705	12660	20231	21892
10507	12835	15161	24373	26369

**To Order, Specify...**

- 1 Model Number
- 2 Top Material
- 3 Edge Style and Thickness
- 4 Edge Color
- 5 Base Color
- 6 Additional Options



**Finish Options**

	<b>Code</b>	<b>Price</b>
Chrome .....		\$ 649
Nickel .....		\$ 710
Powder Coat, Standard .....		n/c
Powder Coat, Premium .....		\$ 165
Platinum .....		\$ 488

Transparent Powder Coat available by sample approval

**Top Options**

Special Laminate .....	<b>TSP</b>	call
Custom Cutout (per cutout) .....	<b>TCC</b>	\$ 120

**Power + Data Options**

Please reference the Power + Data Price List

**Wire Management Options**

1 Oval Brush Grommet, Provide Location Print .....	<b>WOG</b>	\$ 97
1 Round Grommet, Provide Location Print .....	<b>WRG</b>	\$ 76
Eliga Wire Manager (each) .....	<b>WEL</b>	\$ 56





**Finish Options**

	<b>Code</b>	<b>Price</b>
Chrome .....		\$ 649
Nickel .....		\$ 710
Powder Coat, Standard .....		n/c
Powder Coat, Premium .....		\$ 165
Platinum .....		\$ 488

Transparent Powder Coat available by sample approval

**Top Options**

Special Laminate .....	TSP	call
Custom Cutout (per cutout) .....	TCC	\$ 120

**Power + Data Options**

Please reference the Power + Data Price List

**Wire Management Options**

1 Oval Brush Grommet, Provide Location Print .....	WOG	\$ 97
1 Round Grommet, Provide Location Print .....	WRG	\$ 76
Eliga Wire Manager (each) .....	WEL	\$ 56



**Questions?**

800 876 2120

⊕ Indicates Number of Bases

edge ordering code (square corner) >  
top thickness >

top >  
edge >

	Laminate PVC	Laminate Wood	Laminate 1 1/4" Wood	Veneer Wood	Veneer 1 1/4" Wood
	Flat 	Flat 	Square 	Flat 	Square 
	<b>LP7S</b> 1"	<b>LW7S</b> 1"	<b>LWS7</b> 1"	<b>VW7S</b> 1"	<b>VWS7</b> 1"
	1"	1"	1"	1"	1"
	2920	3858	5080	5996	6451
	3428	4654	6258	6693	7207
	3560	4830	6493	7436	8020
	3343	4528	6072	7040	7592
	3813	5266	7157	7891	8520
	3944	5441	7386	8795	9514

Base Style	Table Description	Model #	Product Wt
E8 Standard Height (29")	48 x 72 Fix	<b>EGE8 4872CDFX</b> ②	183
	48 x 84 Fix	<b>EGE8 4884CDFX</b> ②	207
	48 x 96 Fix	<b>EGE8 4896CDFX</b> ②	220
	60 x 72 Fix	<b>EGE8 6072CDFX</b> ②	223
	60 x 84 Fix	<b>EGE8 6084CDFX</b> ②	254
	60 x 96 Fix	<b>EGE8 6096CDFX</b> ②	284

**Note:** Table includes wall mount brackets.

**To Order, Specify...**

- ① Model Number
- ② Top Material
- ③ Edge Style and Thickness
- ④ Edge Color
- ⑤ Base Color
- ⑥ Additional Options



**Finish Options**

	<b>Code</b>	<b>Price</b>
Chrome .....		\$ 649
Nickel .....		\$ 710
Powder Coat, Standard .....		n/c
Powder Coat, Premium .....		\$ 165
Platinum .....		\$ 488

Transparent Powder Coat available by sample approval

**Top Options**

Special Laminate .....	TSP	call
Custom Cutout (per cutout) .....	TCC	\$ 120

**Power + Data Options**

Please reference the Power + Data Price List

**Wire Management Options**

1 Oval Brush Grommet, Provide Location Print .....	WOG	\$ 97
1 Round Grommet, Provide Location Print .....	WRG	\$ 76
Eliga Wire Manager (each) .....	WEL	\$ 56



**Questions?**

800 876 2120

top >  
edge >

edge ordering code (square corner) >  
top thickness >

Laminate PVC	Laminate Wood	Laminate 1 1/4" Wood	Veneer Wood	Veneer 1 1/4" Wood
Flat	Flat	Square	Flat	Square
<b>LP7S</b> 1"	<b>LW7S</b> 1"	<b>LWS7</b> 1"	<b>VW7S</b> 1"	<b>VWS7</b> 1"
1"	1"	1"	1"	1"

Base Style	Table Description	Model #	Product Wt
	24 x 48 Fix	<b>EGTE 2448REFX</b>	55
	24 x 48 Slim-Tilt	<b>EGTE 2448REST</b>	64
	24 x 60 Fix	<b>EGTE 2460REFX</b>	63
	24 x 60 Slim-Tilt	<b>EGTE 2460REST</b>	75
	24 x 72 Fix	<b>EGTE 2472REFX</b>	70
	24 x 72 Slim-Tilt	<b>EGTE 2472REST</b>	85
	24 x 84 Fix	<b>EGTE 2484REFX</b>	94
	24 x 84 Slim-Tilt	<b>EGTE 2484REST</b>	97
	24 x 90 Fix	<b>EGTE 2490REFX</b>	100
	24 x 90 Slim-Tilt	<b>EGTE 2490REST</b>	103
	24 x 96 Fix	<b>EGTE 2496REFX</b>	105
	24 x 96 Slim-Tilt	<b>EGTE 2496REST</b>	109

1"	1"	1"	1"	1"
1247	1697	1956	2573	2727
1767	2217	2468	3036	3239
1332	1819	2181	2780	3012
1849	2217	2780	3291	3523
1528	2134	2458	3012	3268
2041	2655	2968	3523	3780
1611	2364	2780	3302	3595
2128	2882	3291	3813	4105
1742	2567	3028	3598	3914
2269	3063	3541	4138	4422
1862	2726	3232	3706	4029
2378	3246	3744	4212	4543

**Note:** Slim-tilt tables, highlighted above, come standard with Versteel casters.

**To Order, Specify...**

- 1 Model Number
- 2 Top Material
- 3 Edge Style and Thickness
- 4 Edge Color
- 5 Base Color
- 6 Additional Options



**Base Options**

**Code Price**

Casters (4), Dual Wheel Black		
Hard Wheel (to 72" length).....	CAS55	\$ 171
Casters (4), Dual Wheel Black		
Soft Wheel (to 72" length).....	CAS57	\$ 171

**Finish Options**

Chrome .....		\$ 649
Nickel.....		\$ 710
Powder Coat, Standard .....		n/c
Powder Coat, Premium.....		\$ 165
Platinum.....		\$ 488

**Top Options**

Table Link (all four sides) .....	TLK	\$ 251
Special Laminate.....	TSP	call
Custom Cutout (per cutout) .....	TCC	\$ 120

**Power + Data Options**

Please reference the Power + Data Price List

**Wire Management Options**

1 Oval Brush Grommet, Location A .....	WOA	\$ 97
2 Oval Brush Grommets, Location E .....	WOE	\$ 194
1 Oval Brush Grommet, Provide Location Print.....	WOG	\$ 97
1 Round Grommet, Location A .....	WRA	\$ 76
2 Round Grommets, Location E.....	WRE	\$ 152
1 Round Grommet, Provide Location Print .....	WRG	\$ 76





**Base Options**

**Code Price**

Casters (4), Dual Wheel Black		
Hard Wheel (to 72" length).....	CAS55	\$ 171
Casters (4), Dual Wheel Black		
Soft Wheel (to 72" length).....	CAS57	\$ 171

**Finish Options**

Chrome .....		\$ 649
Nickel.....		\$ 710
Powder Coat, Standard .....		n/c
Powder Coat, Premium.....		\$ 165
Platinum.....		\$ 488

**Top Options**

Table Link (all four sides) .....	TLK	\$ 251
Special Laminate.....	TSP	call
Custom Cutout (per cutout) .....	TCC	\$ 120

**Power + Data Options**

Please reference the Power + Data Price List

**Wire Management Options**

1 Oval Brush Grommet, Location A .....	WOA	\$ 97
2 Oval Brush Grommets, Location E .....	WOE	\$ 194
1 Oval Brush Grommet, Provide Location Print.....	WOG	\$ 97
1 Round Grommet, Location A .....	WRA	\$ 76
2 Round Grommets, Location E.....	WRE	\$ 152
1 Round Grommet, Provide Location Print .....	WRG	\$ 76

**Questions?**  
800 876 2120

**Finish Options**

Powder Coat, Standard .....	n/c
Powder Coat, Premium .....	\$ 165
Platinum .....	\$ 488

Transparent Powder Coats available by sample approval

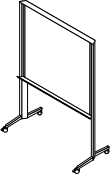
	Description	Model #	Product Wt	Price
	21 x 48 x 69	EG 4342WB	90	3720

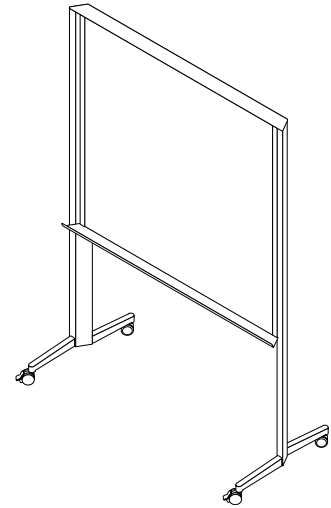

**Features**

- Two sided dry erase writing surface
- Dual wheel locking caster only
- Integrated storage shelf on each side
- Writing surface dimensions: 42" w x 43" h
- Overall width: 48"
- Overall depth: 21"
- Overall height: 69"

**To Order, Specify...**

- 1 Model Number
- 2 Frame Color



**Training Tables**Eliga  
Specifications**VERSTEEL****Tops**

Eliga Training tables are available with rectangle shape tops ranging from 20" to 30" wide and 48" to 96" in length. The 1" laminate tops can be specified with a flat PVC or flat wood edge with square corners.

**Bases**

Fixed T bases are standard with nylon adjustable glides. Slim-tilt T bases are standard with Versteel casters. Fixed bases are inset from the edge of the table to allow for additional leg room.

**Modesty Panels**

Eliga training tables can be specified with or without a modesty panel. Refer to the Modesty Panel Construction Specifications page and the individual pricing pages for additional information.

**Power + Data**

To complete your specification, power and data, along with wire management options, can be added to your table. Refer to the Power + Data Price List.

**NOTE** EXCLUSIONS REGARDING EDGE THICKNESS, BASE FUNCTIONS AND HEIGHT MAY APPLY, REFER TO INDIVIDUAL PRICING PAGES FOR COMPLETE PRODUCT OFFERING

**Laminate Standard Core Construction**

The standard top construction consists of 45-50 lb particleboard, surfaced with a high pressure laminate face. A backer sheet is laminated to the underside of the top. Tops are shipped pre-drilled for field installation of bases and accessories.



**PVC Flat Edge**

Edge of 2mm PVC hot melt banded to the top with 1/8" radius at the top and bottom, with square corners.

Offered in twenty-one (21) standard colors.



**Wood Flat Edge**

Wood banding hot melt banded to the top with 1/8" radius at the top and bottom, with square corners.

Offered in Ash, Cherry, Maple or Walnut materials.

**Shipping Schedule**

**Standard Items**

Laminate, PVC Edge	3-5 WEEKS
Laminate, Wood Edge	3-5 WEEKS

Contact Versteel Customer Service for special lead time requests.

**BIFMA**

All Versteel products are constructed to pass the relevant ANSI/BIFMA standards. For more detailed specifications by series and base style, contact Versteel Customer Service at 800.876.2120.

Additional information regarding warranty, terms and conditions, shipping, care and maintenance, etc. can be found in the All Tables price list.

**Laminate Modesty, General Core Construction**

The modesty panel is constructed of  $\frac{7}{8}$ " thick, 45-50 lb. medium density particle board surfaced with high pressure laminate face on both sides. See individual styles below for panel heights per series. Modesty panel extends the length of the top and is located along the front edge of the table for maximum leg and knee clearance.

**Fixed Modesty (FixMod XM)**

The Fixed Modesty panel is mounted to the top with screws through steel brackets and must be field installed into pre-drilled positions in the top. Panel is 10" high with the following exceptions: Eliga (E1 bases) 7", Paces and Vela 8". All mounting hardware is packed with the modesty panel. Finish details match the top unless specified differently.

**Removable Modesty (RemMod RM)**

The Removable Modesty panel slides into heavy duty steel brackets that are mounted to the top. Simply tighten the handwheels to keep the modesty panel in position or loosen to remove the panel. For storage, the modesty attachment pins can be rotated 90° to prevent marring of the top surfaces. Panel is 10" high with the following exceptions: Eliga (E1 bases) 7", Paces and Vela 8". Finish details match the top unless specified differently.

**Hanging Modesty (HangMod HM)**

The hanging modesty is mounted to the top with a metal hinge that is factory installed. This mechanism pivots if the table is tilted to allow for a 90 degree slim-tilt. All hanging modesty panels are 8½" high. Finish details match the top unless specified differently.

**Form Metal Modesty, General Construction**

The modesty panel is constructed with an aluminum extruded back panel and a perforated hinged steel door. There are three (3) separate unobstructed channels that allow the routing of power and data cables, with a wire exit on the back for the top and middle channel. The Form Modesty panel is 10" high and extends the length of the top. The Form Modesty panel is located along the front edge of the table for maximum leg and knee clearance. Accessory end cap trim kit available.

**Fixed Form Modesty (FixFormMod XF)**

The Fixed Form Modesty panel is mounted to the top with screws through steel brackets. The fixed modesty panel must be field installed into pre-drilled positions in the top. All mounting hardware is packed with the modesty panel. Extruded back panel is black with powder coat options for the perforated steel door. Powder coat finish on perforated door matches the base finish unless specified differently. Transparent powder coat finishes are not available. The panel will be radius with round holes.

**Fixed Lightweight Form Modesty****(FixLightweightFormMod XL)**

The Fixed Lightweight Form Modesty panel is a lightweight version of the Versteel Form Modesty. It is a formed steel perforated panel that is mounted to the top with screws through steel brackets. It must be field installed into pre-drilled positions in the top. A deep channel in the back of the panel allows for the routing of power and data cables inside of the modesty. Mounting hardware is packed with the modesty panel. Powder coat finish on the perforated panel matches the base finish unless specified differently. Transparent powder coat finishes are not available. The panel will be radius with round holes.

**Removable Lightweight Form Modesty****(RemLightweightFormMod RL)**

The Removable Lightweight Form Modesty panel slides into heavy duty steel brackets that are mounted to the top. Simply tighten the handwheels to secure the modesty in position or loosen them to remove the panel. Powder coat finish on the perforated panel matches the base finish unless specified differently. Transparent powder coat finishes are not available. The panel will be radius with round holes.



## Training Tables

Eliga  
How To Order

VERSTEEL

### To Order, Specify...

- 1 Model Number, include top and edge style
- 2 Top Material
  - a. Laminate manufacturer and color
- 3 Edge Color
- 4 Base Color
- 5 Additional Options

base model						finish selections			options	
<b>EG</b>	<b>T1</b>	<b>2472</b>	<b>RE</b>	<b>FX</b>	<b>XM</b>	<b>LP7S</b>	<b>TP WW160-SD</b>	<b>CPRC</b>	<b>PNIM</b>	<b>CAS55</b>
series	base style	top size	top shape	table function	modesty function	top, edge & corner	top laminate manufacture & laminate code	edge color	base color	options

An **EGT1 2472REFX XM L72S** is an Eliga series 24" x 72" rectangle training table with fixed T1 bases, a fixed modesty and a laminate 1" thick top with a PVC edge and square corners.

The codes **TP WW160-SD / CPRC / PNIM** specify a Pionite WW160-SD Pralines & Cream laminate, Pralines & Cream PVC edge and Nimbus bases.

**CAS55** adds dual wheel black hard wheel casters.

Model Number **EGT1 2472REFX XM**



### Orders may be sent via

#### Mailing Address

Versteel  
2332 Cathy Lane  
Jasper IN 47546

### Contact Versteel

Email [contact@versteel.com](mailto:contact@versteel.com)  
Phone 800 876 2120  
812 634 2120

**Laminate**

Versteel's standard offering of laminates includes over 900 laminates from Formica, Nevamar, Pionite and Wilsonart.

Laminate manufacturers change standard offerings frequently, making it possible a standard product can become unavailable. Versteel cannot be responsible for any inconvenience this may cause.

**PVC Edge Colors**

Absolute Acajou . . . . .	.CABA	Pearl . . . . .	.CPEA
Alloy . . . . .	.CALY	Platinum . . . . .	.CPLA
Carbon . . . . .	.CCAR	Pralines & Cream . . . . .	.CPRC
Champagne . . . . .	.CCHA	Shadow . . . . .	.CSHA
Coconut . . . . .	.CCOC	Snow . . . . .	.CSNO
Ebony . . . . .	.CEBO	Stone . . . . .	.CSTO
Florence Walnut . . . . .	.CFLW	Storm . . . . .	.CSTM
Fossil . . . . .	.CFOS	Whisper . . . . .	.CWHI
Graphite . . . . .	.CGRA	White Linen . . . . .	.CWHL
Grey . . . . .	.CGRE		
Kensington Maple . . . . .	.CKEM		
Nimbus . . . . .	.CNIM		

**Wood Edge Species**

Ash . . . . .	.A01	Maple . . . . .	M01
Cherry . . . . .	.C01	Walnut . . . . .	W01

**Wood Edge Finishes**

**Ash**

Beach . . . . .	.WBEA	Fog . . . . .	.WFOG
Chestnut . . . . .	.WCHE	Pebble . . . . .	.WPEB
Drift . . . . .	.WDRI	Whisper . . . . .	.WWHI
Fawn . . . . .	.WFAW		

**Cherry**

Blossom Cherry . . . . .	.WBLC	Java Cherry . . . . .	.WJAC
Cordovan Cherry . . . . .	.WCNC	Millwork Cherry . . . . .	.WMWC
Golden Cherry . . . . .	.WGNC		

**Maple**

Caramel Maple . . . . .	.WCMM	Sugar Maple . . . . .	.WSUM
Solar Maple . . . . .	.WSLM		

**Walnut**

Brighton Walnut . . . . .	.WBRW	Natural Walnut . . . . .	.WNAW
Espresso Walnut . . . . .	.WESW		

**Studio Steel®**

Versteel’s “urban fabrication” process leaves the telltale signs of welding and assembly on the surface, highlighting a manufacturing aesthetic. Choosing a clear or transparent powder coat is recommended, allowing tonal striations (created as a result of extreme heat), natural textures, and the inherent qualities of raw steel to show through.

Studio Steel Process . . . . . \$165

**Powder Coat Finishes**

All powder coat finishes in the Versteel offering have been formulated with the use of epoxy, polyester or epoxy and polyester blends to maximize the finish durability.

**Powder Coat Finish Options**

Powder Coat – Standard . . . . . n/c  
 Powder Coat – Premium (Hope). . . . . \$165  
 Powder Coat – Premium (Platinum) . . . . . \$488

**Powder Coat Colors**

Alloy . . . . .	.PALY	Mint . . . . .	.PMNT
Amethyst . . . . .	.PAME	Navy . . . . .	.PNAV
Anthracite . . . . .	.PANT	Nimbus. . . . .	.PNIM
Black Anodized. . . . .	.PBLA	Nutmeg . . . . .	.PNUT
Bronze . . . . .	.PBRO	◆ Pacific . . . . .	.PPAC
Calypso . . . . .	.PCAL	Pearl . . . . .	.PPEA
Carbon. . . . .	.PCAR	Pebble . . . . .	.PPEB
Champagne . . . . .	.PCHA	Ⓟ Platinum . . . . .	.PPLA
Coconut . . . . .	.PCOC	Poppy. . . . .	.PPOP
◆ Copper. . . . .	.PCOP	◆ Raven. . . . .	.PRAV
Crimson . . . . .	.PCRI	Royal . . . . .	.PROY
◆ Crystal . . . . .	.PCRY	Seaside . . . . .	.PSEA
Daffodil. . . . .	.PDAF	Shipyards . . . . .	.PSHI
Ebony. . . . .	.PEBO	Silver . . . . .	.PSIL
Forest. . . . .	.PFOR	Snow . . . . .	.PSNO
Fossil . . . . .	.PFOS	Stone . . . . .	.PSTO
◆ Garnet . . . . .	.PGAR	Storm. . . . .	.PSTM
◆ Gold. . . . .	.PGOL	Terra Cotta . . . . .	.PTEC
Graphite . . . . .	.PGRA	Whisper . . . . .	.PWHI
Ⓟ Hope . . . . .	.PHOP	White Linen . . . . .	.PWHL
Kelly Green . . . . .	.PKEG	Powder Coat Alternative .	.OPA
◆ Matte . . . . .	.PMAT		
Mica. . . . .	.PMIC		

**Transparent Powder Coats (indicated by ◆)**

Please note that the transparent characteristics of these powders allow all natural welds and textures inherent to raw steel to be visible. Transparent powder coat available on Eliga upon sample approval.

**Premium Powder Coats (indicated by Ⓟ)**

Versteel’s premium process uses specially formulated powder coats for a truly unique color palette.

**Chrome**

Versteel applies a deep luster chrome plated finish. Chrome is the most durable finish available. Specify Chrome and add \$649 list per table.

Chrome . . . . . ECHR

**Nickel**

Versteel applies a nickel plated finish with a clear coat applied for durability. Specify Nickel and add \$710 list per table.

Nickel . . . . . ENKL

**NOTE** CHROME AND NICKEL ARE NOT AVAILABLE ON THE ELIGA WHITEBOARD

**Finish Reference & Samples**

For finish color reference, please refer to our website. Contact Versteel Customer Service to receive actual color samples for color matches and final color approval.

**Special Laminate****Call for quotation**

Specify code **TSP** (Special Laminate), indicate the quoted charges per table

Special laminates and patterns can be specified as an option. To specify, contact Versteel Customer Service for availability and pricing.

**NOTE** LAMINATES IN STANDARD COLORS AND TEXTURES FROM FORMICA, NEVAMAR, PIONITE AND WILSONART ARE STANDARD

**CAUTION** LAMINATE MANUFACTURERS CHANGE STANDARD OFFERINGS FREQUENTLY, MAKING IT POSSIBLE A STANDARD PRODUCT CAN BECOME UNAVAILABLE. VERSTEEL CANNOT BE RESPONSIBLE FOR ANY INCONVENIENCE THIS MAY CAUSE.

**Custom PVC Color Match****Call for quotation / one time charge per color, per order**

Specify code **OCF** (Custom PVC Color Match), add cost from Versteel quotation

PVC Color Match can be the selection of a color that is available from a Versteel supplier or a new custom color developed for the order. Minimum footage requirements mean that the amount of material needed for your order will effect the cost.

For PVC Color Matching you must supply a color reference sample. Versteel will review the sample for possible existing colors available and send a sample for customer approval. If no color match exists, a custom match will be developed and sampled for customer approval before a production schedule is established.

**Powder Coat Alternative****Call for quotation**

Specify code **OPA** (Powder Coat Alternative), add cost from Versteel quotation

Powder Coat Alternative is available from Versteel. The entire RAL color reference along with hundreds of other color and finishes are available.

For Powder Coat Alternative matching, you must supply a color reference sample, or an RAL number. Versteel will review the sample for possible existing colors available and send a sample for customer approval. If no color match exists a custom match can be developed. Call Versteel Customer Service for associated upcharges on custom color development.

**Stain Finish Match**

\$996 / one time charge per finish, per order

Specify code **OSM** (Stain Finish Match), add \$996.00 list per finish, per order

Alternative Stain Finishes are available for veneer and wood edged tops.

For Stain Finish Matching you must supply two 4" x 4" finish color and grain reference samples. An expertly finish matched sample will be provided for customer approval.

**NOTE** CUSTOMS OR ALTERNATIVES MAY AFFECT STANDARD PRODUCTION SCHEDULES

**Alternate Table Height 32" and Under****\$196 / table**

Specify code **BAH** (*Alternate Height 32" and under*), indicate desired table height (32" or less), add \$196.00 list per table

Suggested typing height table is 26 3/4"

Suggested wheelchair height table is 32"

Suggested stand up height table is 42"

**NOTE** FOR OTHER TABLE HEIGHT REQUIREMENTS CONTACT VERSTEEL CUSTOMER SERVICE FOR STRUCTURAL DETAILS, PRICING AND AVAILABILITY

**NOTE** NOT ALL ELIGA TABLES ARE AVAILABLE WITH AN ALTERNATE TABLE HEIGHT. REFER TO PRICING PAGES OR CONTACT VERSTEEL CUSTOMER SERVICE.

**Casters - Dual Hard Wheel Black Hard or Soft****\$171 / table**

Specify code CAS55 (Hard Wheel) or CAS57 (Soft Wheel), add \$171.00 list per table

Dual wheel, black, 2" diameter, standard locking casters are available on X1 and TE base styles. Each is fitted into a reinforced caster receiver and must be specified at time of order. Caster option does not change the overall height of the table. See individual product pages for availability and ordering code.

**Top Custom Cutout****\$120 / cutout**

Specify code **TCC** (*Top Custom Cutout*), add \$120.00 list per cutout

Top Custom Cutout requires a drawing for production and is subject to approvals.

**Table Link****\$251 / table**

Specify code **TLK** (*Table Link*), add \$251.00 list per table

Table Link is for linking Versteel table configurations in typical room situations.

Table link will prevent the accidental disconnection of power supply to adjacent tables. Available on tables with PVC, 3mm Wood, Wood Square, Wood Fluted and Ergo user side edge details.



Closed end link brackets are provided for tops without bases or tables with a base that does not allow the table to stand alone.

**Table Link - Ends Only****\$135 / table**

Specify code **TLE** (*Table Link - Ends Only*), add \$135.00 list per table

Table Link is for linking Versteel table configurations in typical room situations.

Specify Table Link - Ends Only when your configuration requires linking on the table ends only. Available on tables with PVC, 3mm Wood, Wood Square, Wood Fluted and Ergo user side edge details. Table Link - Ends Only is included with electrical package options. This will prevent the accidental disconnection of power supply to adjacent tables.







Questions?

800 876 2120

top >  
edge >

Laminate PVC	Laminate Wood
Flat	Flat
edge ordering code (square corner) > top thickness >	
<b>LP7S</b> 1"	<b>LW7S</b> 1"
top thickness price >	
1"	1"

Base Style	Table Description	Model #	Product Wt	1"	1"
<p>TI</p> <p><b>Note:</b> Slim-tilt tables, highlighted above, come standard with Versteel casters.</p> <p><b>Note:</b> Training tables are often used with lightweight computer accessories. For heavy duty applications, such as large scale computer equipment, multiple monitor mounts, etc., Versteel suggests adding a third leg or stretcher. The price of the 84", 90" and 96" models include a stretcher rail required for additional support. Contact Customer Service if you have specific application concerns or questions.</p>	20 x 48 Fix	EGT1 2048REFX	49	1189	1521
	20 x 48 Slim-Tilt	EGT1 2048REST	59	1706	2041
	20 x 48 Fix w/FixMod	EGT1 2048REFX XM	62	1488	2025
	20 x 48 Fix w/RemMod	EGT1 2048REFX RM	52	1511	2040
	20 x 48 Slim-Tilt w/RemMod	EGT1 2048REST RM	62	2065	2603
	20 x 48 Slim-Tilt w/HangMod	EGT1 2048REST HM	72	2065	2603
	20 x 48 Fix w/FixLightweightFormMod	EGT1 2048REFX XL	61	1511	2040
	20 x 48 Fix w/RemLightweightFormMod	EGT1 2048REFX RL	61	1511	2040
	20 x 48 Fix w/FixFormMod	EGT1 2048REFX XF	71	1630	1994
	20 x 60 Fix	EGT1 2060REFX	55	1290	1667
	20 x 60 Slim-Tilt	EGT1 2060REST	67	1803	2184
	20 x 60 Fix w/FixMod	EGT1 2060REFX XM	70	1716	2477
	20 x 60 Fix w/RemMod	EGT1 2060REFX RM	58	1760	2526
	20 x 60 Slim-Tilt w/RemMod	EGT1 2060REST RM	70	2281	3041
	20 x 60 Slim-Tilt w/HangMod	EGT1 2060REST HM	82	2281	3041
	20 x 60 Fix w/FixLightweightFormMod	EGT1 2060REFX XL	70	1760	2530
	20 x 60 Fix w/RemLightweightFormMod	EGT1 2060REFX RL	70	1760	2530
	20 x 60 Fix w/FixFormMod	EGT1 2060REFX XF	82	2041	2423
	20 x 72 Fix	EGT1 2072REFX	61	1348	1807
	20 x 72 Slim-Tilt	EGT1 2072REST	76	1864	2325
	20 x 72 Fix w/FixMod	EGT1 2072REFX XM	78	1859	3021
	20 x 72 Fix w/RemMod	EGT1 2072REFX RM	65	1903	3066
	20 x 72 Slim-Tilt w/RemMod	EGT1 2072REST RM	80	2424	3586
	20 x 72 Slim-Tilt w/HangMod	EGT1 2072REST HM	93	2424	3586
20 x 72 Fix w/FixLightweightFormMod	EGT1 2072REFX XL	79	1906	3071	
20 x 72 Fix w/RemLightweightFormMod	EGT1 2072REFX RL	79	1906	3071	
20 x 72 Fix w/FixFormMod	EGT1 2072REFX XF	93	2102	2559	
20 x 84 Fix	EGT1 2084REFX	83	1488	2126	
20 x 84 Slim-Tilt	EGT1 2084REST	86	2007	2643	
20 x 84 Fix w/FixMod	EGT1 2084REFX XM	103	2125	3155	
20 x 84 Fix w/RemMod	EGT1 2084REFX RM	87	2153	3177	
20 x 84 Slim-Tilt w/RemMod	EGT1 2084REST RM	90	2796	4362	
20 x 84 Slim-Tilt w/HangMod	EGT1 2084REST HM	106	2796	4362	

To Order, Specify...

- 1 Model Number
- 2 Top Material
- 3 Edge Style and Thickness
- 4 Edge Color
- 5 Base Color
- 6 Additional Options



**Base Options**

**Code Price**

Casters (4), Dual Wheel Black		
Hard Wheel (to 72" length).....	CAS55	\$ 171
Casters (4), Dual Wheel Black		
Soft Wheel (to 72" length).....	CAS57	\$ 171

**Finish Options**

Chrome .....		\$ 649
Nickel.....		\$ 710
Powder Coat, Standard .....		n/c
Powder Coat, Premium.....		\$ 165
Platinum.....		\$ 488

**Top Options**

Table Link (all four sides) .....	TLK	\$ 251
Table Link (20" ends only) .....	TLE	\$ 135
Special Laminate.....	TSP	call
Custom Cutout (per cutout) .....	TCC	\$ 120

**Power + Data Options**

Please reference the Power + Data Price List



**Wire Management Options**

1 Oval Brush Grommet, Location A .....	WOA	\$ 97
2 Oval Brush Grommets, Location E .....	WOE	\$ 194
1 Oval Brush Grommet, Provide Location Print. ....	WOG	\$ 97
1 Round Grommet, Location A .....	WRA	\$ 76
2 Round Grommets, Location E.....	WRE	\$ 152
1 Round Grommet, Provide Location Print .....	WRG	\$ 76



**Questions?**

800 876 2120

top >	Laminate PVC	Laminate Wood
edge >	Flat 	Flat 
edge ordering code (square corner) >	<b>LP7S</b>	<b>LW7S</b>
top thickness >	1"	1"
top thickness price >	1"	1"

Base Style	Table Description	Model #	Product Wt	1"	1"
 TI	20 x 90 Fix	<b>EGT1 2090REFX</b>	88	1578	2360
	20 x 90 Slim-Tilt	<b>EGT1 2090REST</b>	91	2062	2849
	20 x 90 Fix w/FixMod	<b>EGT1 2090REFX XM</b>	110	2501	4068
	20 x 90 Fix w/RemMod	<b>EGT1 2090REFX RM</b>	92	2542	4110
	20 x 90 Slim-Tilt w/RemMod	<b>EGT1 2090REST RM</b>	95	3059	4624
	20 x 90 Slim-Tilt w/HangMod	<b>EGT1 2090REST HM</b>	113	3059	4624
	20 x 96 Fix	<b>EGT1 2096REFX</b>	92	1620	2403
	20 x 96 Slim-Tilt	<b>EGT1 2096REST</b>	96	2136	2920
	20 x 96 Fix w/FixMod	<b>EGT1 2096REFX XM</b>	116	2501	4068
	20 x 96 Fix w/RemMod	<b>EGT1 2096REFX RM</b>	97	2542	4110
	20 x 96 Slim-Tilt w/RemMod	<b>EGT1 2096REST RM</b>	101	3059	4624
	20 x 96 Slim-Tilt w/HangMod	<b>EGT1 2096REST HM</b>	120	3059	4624

**Note:** Slim-tilt tables, highlighted above, come standard with Versteel casters.

**Note:** Training tables are often used with lightweight computer accessories. For heavy duty applications, such as large scale computer equipment, multiple monitor mounts, etc., Versteel suggests adding a third leg or stretcher. The price of the 84", 90" and 96" models include a stretcher rail required for additional support. Contact Customer Service if you have specific application concerns or questions.

**To Order, Specify...**

- 1 Model Number
- 2 Top Material
- 3 Edge Style and Thickness
- 4 Edge Color
- 5 Base Color
- 6 Additional Options



**Finish Options**

Chrome .....	\$ 649
Nickel .....	\$ 710
Powder Coat, Standard .....	n/c
Powder Coat, Premium .....	\$ 165
Platinum .....	\$ 488

**Top Options**

Table Link (all four sides) .....	TLK	\$ 251
Table Link (20" ends only) .....	TLE	\$ 135
Special Laminate .....	TSP	call
Custom Cutout (per cutout) .....	TCC	\$ 120

**Power + Data Options**

Please reference the Power + Data Price List

**Wire Management Options**

1 Oval Brush Grommet, Location A .....	WOA	\$ 97
2 Oval Brush Grommets, Location E .....	WOE	\$ 194
1 Oval Brush Grommet, Provide Location Print. ....	WOG	\$ 97
1 Round Grommet, Location A .....	WRA	\$ 76
2 Round Grommets, Location E .....	WRE	\$ 152
1 Round Grommet, Provide Location Print .....	WRG	\$ 76



**Questions?**

800 876 2120

top >  
edge >

Laminate PVC	Laminate Wood
Flat	Flat
edge ordering code (square corner) > top thickness >	
<b>LP7S</b> 1"	<b>LW7S</b> 1"
top thickness price >	
1"	1"

Base Style	Table Description	Model #	Product Wt	1"	1"
	24 x 48 Fix	EGT1 2448REFX	55	1247	1697
	24 x 48 Slim-Tilt	EGT1 2448REST	64	1767	2217
	24 x 48 Fix w/FixMod	EGT1 2448REFX XM	68	1563	1602
	24 x 48 Fix w/RemMod	EGT1 2448REFX RM	57	1584	1652
	24 x 48 Slim-Tilt w/RemMod	EGT1 2448REST RM	66	2119	2170
	24 x 48 Slim-Tilt w/HangMod	EGT1 2448REST HM	77	2119	2170
	24 x 48 Fix w/FixLightweightFormMod	EGT1 2448REFX XL	67	1584	1652
	24 x 48 Fix w/RemLightweightFormMod	EGT1 2448REFX RL	67	1584	1652
	24 x 48 Fix w/FixFormMod	EGT1 2448REFX XF	77	1697	1754
	24 x 60 Fix	EGT1 2460REFX	63	1332	1894
	24 x 60 Slim-Tilt	EGT1 2460REST	75	1849	2217
	24 x 60 Fix w/FixMod	EGT1 2460REFX XM	78	1759	1836
	24 x 60 Fix w/RemMod	EGT1 2460REFX RM	66	1808	1886
	24 x 60 Slim-Tilt w/RemMod	EGT1 2460REST RM	78	2325	2398
	24 x 60 Slim-Tilt w/HangMod	EGT1 2460REST HM	90	2325	2398
	24 x 60 Fix w/FixLightweightFormMod	EGT1 2460REFX XL	78	1808	1886
	24 x 60 Fix w/RemLightweightFormMod	EGT1 2460REFX RL	78	1808	1886
	24 x 60 Fix w/FixFormMod	EGT1 2460REFX XF	90	2082	2158
	24 x 72 Fix	EGT1 2472REFX	70	1528	2134
	24 x 72 Slim-Tilt	EGT1 2472REST	85	2041	2655
	24 x 72 Fix w/FixMod	EGT1 2472REFX XM	87	2030	2095
	24 x 72 Fix w/RemMod	EGT1 2472REFX RM	74	2076	2143
	24 x 72 Slim-Tilt w/RemMod	EGT1 2472REST RM	89	2593	2662
	24 x 72 Slim-Tilt w/HangMod	EGT1 2472REST HM	102	2593	2662
24 x 72 Fix w/FixLightweightFormMod	EGT1 2472REFX XL	88	2079	2145	
24 x 72 Fix w/RemLightweightFormMod	EGT1 2472REFX RL	88	2079	2145	
24 x 72 Fix w/FixFormMod	EGT1 2472REFX XF	102	2273	2340	
24 x 84 Fix	EGT1 2484REFX	94	1611	2364	
24 x 84 Slim-Tilt	EGT1 2484REST	97	2128	2882	
24 x 84 Fix w/FixMod	EGT1 2484REFX XM	114	2280	2286	
24 x 84 Fix w/RemMod	EGT1 2484REFX RM	98	2309	2320	
24 x 84 Slim-Tilt w/RemMod	EGT1 2484REST RM	101	2843	4069	
24 x 84 Slim-Tilt w/HangMod	EGT1 2484REST HM	117	2843	4069	

**Note:** Slim-tilt tables, highlighted above, come standard with Versteel casters.

**Note:** Training tables are often used with lightweight computer accessories. For heavy duty applications, such as large scale computer equipment, multiple monitor mounts, etc., Versteel suggests adding a third leg or stretcher. The price of the 84", 90" and 96" models include a stretcher rail required for additional support. Contact Customer Service if you have specific application concerns or questions.

**To Order, Specify...**

- 1 Model Number
- 2 Top Material
- 3 Edge Style and Thickness
- 4 Edge Color
- 5 Base Color
- 6 Additional Options



**Base Options**

**Code Price**

Casters (4), Dual Wheel Black		
Hard Wheel (to 72" length).....	CAS55	\$ 171
Casters (4), Dual Wheel Black		
Soft Wheel (to 72" length).....	CAS57	\$ 171

**Finish Options**

Chrome .....		\$ 649
Nickel.....		\$ 710
Powder Coat, Standard .....		n/c
Powder Coat, Premium.....		\$ 165
Platinum.....		\$ 488

**Top Options**

Table Link (all four sides) .....	TLK	\$ 251
Table Link (24" ends only) .....	TLE	\$ 135
Special Laminate.....	TSP	call
Custom Cutout (per cutout) .....	TCC	\$ 120

**Power + Data Options**

Please reference the Power + Data Price List



**Wire Management Options**

1 Oval Brush Grommet, Location A .....	WOA	\$ 97
2 Oval Brush Grommets, Location E .....	WOE	\$ 194
1 Oval Brush Grommet, Provide Location Print. ....	WOG	\$ 97
1 Round Grommet, Location A .....	WRA	\$ 76
2 Round Grommets, Location E.....	WRE	\$ 152
1 Round Grommet, Provide Location Print .....	WRG	\$ 76



**Questions?**

800 876 2120

top >	Laminate PVC	Laminate Wood
edge >	Flat 	Flat 
edge ordering code (square corner) >	<b>LP7S</b>	<b>LW7S</b>
top thickness >	1"	1"
top thickness price >	1"	1"

Base Style	Table Description	Model #	Product Wt	1"	1"
 TI	24 x 90 Fix	<b>EGT1 2490REFX</b>	100	1742	2567
	24 x 90 Slim-Tilt	<b>EGT1 2490REST</b>	103	2269	3063
	24 x 90 Fix w/FixMod	<b>EGT1 2490REFX XM</b>	122	2762	4335
	24 x 90 Fix w/RemMod	<b>EGT1 2490REFX RM</b>	104	2880	3746
	24 x 90 Slim-Tilt w/RemMod	<b>EGT1 2490REST RM</b>	107	3395	4260
	24 x 90 Slim-Tilt w/HangMod	<b>EGT1 2490REST HM</b>	125	3395	4260
	24 x 96 Fix	<b>EGT1 2496REFX</b>	105	1862	2726
	24 x 96 Slim-Tilt	<b>EGT1 2496REST</b>	109	2378	3246
	24 x 96 Fix w/FixMod	<b>EGT1 2496REFX XM</b>	129	2762	4335
	24 x 96 Fix w/RemMod	<b>EGT1 2496REFX RM</b>	110	2880	3746
	24 x 96 Slim-Tilt w/RemMod	<b>EGT1 2496REST RM</b>	114	3395	4260
	24 x 96 Slim-Tilt w/HangMod	<b>EGT1 2496REST HM</b>	133	3395	4260

**Note:** Slim-tilt tables, highlighted above, come standard with Versteel casters.

**Note:** Training tables are often used with lightweight computer accessories. For heavy duty applications, such as large scale computer equipment, multiple monitor mounts, etc., Versteel suggests adding a third leg or stretcher. The price of the 84", 90" and 96" models include a stretcher rail required for additional support. Contact Customer Service if you have specific application concerns or questions.

**To Order, Specify...**

- 1 Model Number
- 2 Top Material
- 3 Edge Style and Thickness
- 4 Edge Color
- 5 Base Color
- 6 Additional Options



**Finish Options**

Chrome .....	\$ 649
Nickel .....	\$ 710
Powder Coat, Standard .....	n/c
Powder Coat, Premium .....	\$ 165
Platinum .....	\$ 488

**Top Options**

Table Link (all four sides) .....	TLK	\$ 251
Table Link (24" ends only) .....	TLE	\$ 135
Special Laminate .....	TSP	call
Custom Cutout (per cutout) .....	TCC	\$ 120

**Power + Data Options**

Please reference the Power + Data Price List

**Wire Management Options**

1 Oval Brush Grommet, Location A .....	WOA	\$ 97
2 Oval Brush Grommets, Location E .....	WOE	\$ 194
1 Oval Brush Grommet, Provide Location Print. ....	WOG	\$ 97
1 Round Grommet, Location A .....	WRA	\$ 76
2 Round Grommets, Location E .....	WRE	\$ 152
1 Round Grommet, Provide Location Print .....	WRG	\$ 76



**Questions?**

800 876 2120

top >  
edge >

Laminate PVC	Laminate Wood
Flat	Flat
edge ordering code (square corner) > top thickness >	
<b>LP7S</b> 1"	<b>LW7S</b> 1"
top thickness price >	
1"	1"

Base Style	Table Description	Model #	Product Wt	1"	1"
<p>TI</p> <p><b>Note:</b> Slim-tilt tables, highlighted above, come standard with Versteel casters.</p> <p><b>Note:</b> Training tables are often used with lightweight computer accessories. For heavy duty applications, such as large scale computer equipment, multiple monitor mounts, etc., Versteel suggests adding a third leg or stretcher. The price of the 84", 90" and 96" models include a stretcher rail required for additional support. Contact Customer Service if you have specific application concerns or questions.</p>	30 x 48 Fix	EGT1 3048REFX	63	1375	1846
	30 x 48 Slim-Tilt	EGT1 3048REST	75	1895	2364
	30 x 48 Fix w/FixMod	EGT1 3048REFX XM	76	1692	2364
	30 x 48 Fix w/RemMod	EGT1 3048REFX RM	66	1721	2381
	30 x 48 Slim-Tilt w/RemMod	EGT1 3048REST RM	78	2259	2936
	30 x 48 Slim-Tilt w/HangMod	EGT1 3048REST HM	88	2259	2936
	30 x 48 Fix w/FixLightweightFormMod	EGT1 3048REFX XL	75	1721	2381
	30 x 48 Fix w/RemLightweightFormMod	EGT1 3048REFX RL	75	1721	2775
	30 x 48 Fix w/FixFormMod	EGT1 3048REFX XF	85	1841	2345
	30 x 60 Fix	EGT1 3060REFX	73	1460	2065
	30 x 60 Slim-Tilt	EGT1 3060REST	87	1978	2581
	30 x 60 Fix w/FixMod	EGT1 3060REFX XM	88	1890	2875
	30 x 60 Fix w/RemMod	EGT1 3060REFX RM	76	1937	2953
	30 x 60 Slim-Tilt w/RemMod	EGT1 3060REST RM	90	2455	3439
	30 x 60 Slim-Tilt w/HangMod	EGT1 3060REST HM	102	2455	3439
	30 x 60 Fix w/FixLightweightFormMod	EGT1 3060REFX XL	88	1937	2919
	30 x 60 Fix w/RemLightweightFormMod	EGT1 3060REFX RL	88	1937	2919
	30 x 60 Fix w/FixFormMod	EGT1 3060REFX XF	100	2209	2816
	30 x 72 Fix	EGT1 3072REFX	83	1573	2283
	30 x 72 Slim-Tilt	EGT1 3072REST	100	2092	2798
	30 x 72 Fix w/FixMod	EGT1 3072REFX XM	100	2080	3497
	30 x 72 Fix w/RemMod	EGT1 3072REFX RM	87	2128	3541
	30 x 72 Slim-Tilt w/RemMod	EGT1 3072REST RM	104	2646	4058
	30 x 72 Slim-Tilt w/HangMod	EGT1 3072REST HM	117	2646	4058
	30 x 72 Fix w/FixLightweightFormMod	EGT1 3072REFX XL	101	2129	3542
	30 x 72 Fix w/RemLightweightFormMod	EGT1 3072REFX RL	101	2129	3542
	30 x 72 Fix w/FixFormMod	EGT1 3072REFX XF	115	2327	3035
	30 x 84 Fix	EGT1 3084REFX	109	1687	2576
	30 x 84 Slim-Tilt	EGT1 3084REST	114	2202	3092
	30 x 84 Fix w/FixMod	EGT1 3084REFX XM	129	2368	3765
	30 x 84 Fix w/RemMod	EGT1 3084REFX RM	113	2401	3788
	30 x 84 Slim-Tilt w/RemMod	EGT1 3084REST RM	118	2842	4654
	30 x 84 Slim-Tilt w/HangMod	EGT1 3084REST HM	134	2842	4654

**To Order, Specify...**

- 1 Model Number
- 2 Top Material
- 3 Edge Style and Thickness
- 4 Edge Color
- 5 Base Color
- 6 Additional Options



**Base Options**

**Code Price**

Casters (4), Dual Wheel Black		
Hard Wheel (to 72" length).....	CAS55	\$ 171
Casters (4), Dual Wheel Black		
Soft Wheel (to 72" length).....	CAS57	\$ 171

**Finish Options**

Chrome .....		\$ 649
Nickel .....		\$ 710
Powder Coat, Standard .....		n/c
Powder Coat, Premium.....		\$ 165
Platinum.....		\$ 488

**Top Options**

Table Link (all four sides) .....	TLK	\$ 251
Table Link (30" ends only) .....	TLE	\$ 135
Special Laminate.....	TSP	call
Custom Cutout (per cutout) .....	TCC	\$ 120

**Power + Data Options**

Please reference the Power + Data Price List

**Wire Management Options**

1 Oval Brush Grommet, Location A .....	WOA	\$ 97
2 Oval Brush Grommets, Location E .....	WOE	\$ 194
1 Oval Brush Grommet, Provide Location Print. ....	WOG	\$ 97
1 Round Grommet, Location A .....	WRA	\$ 76
2 Round Grommets, Location E.....	WRE	\$ 152
1 Round Grommet, Provide Location Print .....	WRG	\$ 76



**Questions?**

800 876 2120

top >	Laminate PVC	Laminate Wood
edge >	Flat	Flat
edge ordering code (square corner) >	<b>LP7S</b>	<b>LW7S</b>
top thickness >	1"	1"
top thickness price >	1"	1"

Base Style	Table Description	Model #	Product Wt	1"	1"
<p>TI</p>	30 x 90 Fix	<b>EGT1 3090REFX</b>	116	1800	2780
	30 x 90 Slim-Tilt	<b>EGT1 3090REST</b>	121	2309	3238
	30 x 90 Fix w/FixMod	<b>EGT1 3090REFX XM</b>	138	2776	4618
	30 x 90 Fix w/RemMod	<b>EGT1 3090REFX RM</b>	120	2819	4662
	30 x 90 Slim-Tilt w/RemMod	<b>EGT1 3090REST RM</b>	125	3336	5178
	30 x 90 Slim-Tilt w/HangMod	<b>EGT1 3090REST HM</b>	143	3336	5178
	30 x 96 Fix	<b>EGT1 3096REFX</b>	122	1894	2953
	30 x 96 Slim-Tilt	<b>EGT1 3096REST</b>	128	2412	3472
	30 x 96 Fix w/FixMod	<b>EGT1 3096REFX XM</b>	146	2776	4618
	30 x 96 Fix w/RemMod	<b>EGT1 3096REFX RM</b>	127	2819	4662
	30 x 96 Slim-Tilt w/RemMod	<b>EGT1 3096REST RM</b>	133	3336	5178
	30 x 96 Slim-Tilt w/HangMod	<b>EGT1 3096REST HM</b>	152	3336	5178

**Note:** Slim-tilt tables, highlighted above, come standard with Versteel casters.

**Note:** Training tables are often used with lightweight computer accessories. For heavy duty applications, such as large scale computer equipment, multiple monitor mounts, etc., Versteel suggests adding a third leg or stretcher. The price of the 84", 90" and 96" models include a stretcher rail required for additional support. Contact Customer Service if you have specific application concerns or questions.

**To Order, Specify...**

- 1 Model Number
- 2 Top Material
- 3 Edge Style and Thickness
- 4 Edge Color
- 5 Base Color
- 6 Additional Options



**Finish Options**

Chrome .....	\$ 649
Nickel .....	\$ 710
Powder Coat, Standard .....	n/c
Powder Coat, Premium .....	\$ 165
Platinum .....	\$ 488

**Top Options**

Table Link (all four sides) .....	TLK	\$ 251
Table Link (30" ends only) .....	TLE	\$ 135
Special Laminate .....	TSP	call
Custom Cutout (per cutout) .....	TCC	\$ 120

**Power + Data Options**

Please reference the Power + Data Price List

**Wire Management Options**

1 Oval Brush Grommet, Location A .....	WOA	\$ 97
2 Oval Brush Grommets, Location E .....	WOE	\$ 194
1 Oval Brush Grommet, Provide Location Print. ....	WOG	\$ 97
1 Round Grommet, Location A .....	WRA	\$ 76
2 Round Grommets, Location E .....	WRE	\$ 152
1 Round Grommet, Provide Location Print .....	WRG	\$ 76



**Questions?**

800 876 2120

top > edge >	Laminate PVC	Laminate Wood
	Flat	Flat
edge ordering code (square corner) > top thickness >	<b>LP7S</b> 1"	<b>LW7S</b> 1"
top thickness price >	1"	1"

Base Style	Table Description	Model #	Product Wt	1"	1"
<p>TI</p> <p><b>Note:</b> Training tables are often used with lightweight computer accessories. For heavy duty applications, such as large scale computer equipment, multiple monitor mounts, etc., Versteel suggests adding a third leg or stretcher. The price of the 84", 90" and 96" models include a stretcher rail required for additional support. Contact Customer Service if you have specific application concerns or questions.</p>	36 x 48 Fix	EGT1 3648REFX	71	1514	2030
	36 x 48 Tilt	EGT1 3648RETL	83	2070	2584
	36 x 48 Fix w/FixMod	EGT1 3648REFX XM	84	1860	2602
	36 x 48 Fix w/RemMod	EGT1 3648REFX RM	74	1891	2620
	36 x 48 Tilt w/RemMod	EGT1 3648RETL RM	86	2468	3213
	36 x 48 Tilt w/HangMod	EGT1 3648RETL HM	96	2468	3213
	36 x 48 Fix w/FixLightweightFormMod	EGT1 3648REFX XL	83	1891	2620
	36 x 48 Fix w/RemLightweightFormMod	EGT1 3648REFX RL	83	1891	3055
	36 x 48 Fix w/FixFormMod	EGT1 3648REFX XF	93	2027	2581
	36 x 60 Fix	EGT1 3660REFX	83	1608	2268
	36 x 60 Tilt	EGT1 3660RETL	97	2158	2822
	36 x 60 Fix w/FixMod	EGT1 3660REFX XM	98	2079	3160
	36 x 60 Fix w/RemMod	EGT1 3660REFX RM	86	2129	3211
	36 x 60 Tilt w/RemMod	EGT1 3660RETL RM	100	2685	3769
	36 x 60 Tilt w/HangMod	EGT1 3660RETL HM	112	2685	3769
	36 x 60 Fix w/FixLightweightFormMod	EGT1 3660REFX XL	98	2129	3210
	36 x 60 Fix w/RemLightweightFormMod	EGT1 3660REFX RL	98	2129	3210
	36 x 60 Fix w/FixFormMod	EGT1 3660REFX XF	110	2434	3097
	36 x 72 Fix	EGT1 3672REFX	95	1730	2511
	36 x 72 Tilt	EGT1 3672RETL	112	2285	3061
	36 x 72 Fix w/FixMod	EGT1 3672REFX XM	112	2288	3847
	36 x 72 Fix w/RemMod	EGT1 3672REFX RM	99	2343	3894
	36 x 72 Tilt w/RemMod	EGT1 3672RETL RM	114	2893	4450
	36 x 72 Tilt w/HangMod	EGT1 3672RETL HM	129	2893	4450
	36 x 72 Fix w/FixLightweightFormMod	EGT1 3672REFX XL	113	2345	3898
	36 x 72 Fix w/RemLightweightFormMod	EGT1 3672REFX RL	113	2345	3898
	36 x 72 Fix w/FixFormMod	EGT1 3672REFX XF	127	2559	3338
	36 x 84 Fix	EGT1 3684REFX	123	1855	2831
	36 x 84 Tilt	EGT1 3684RETL	128	2406	3388
	36 x 84 Fix w/FixMod	EGT1 3684REFX XM	143	2607	4140
	36 x 84 Fix w/RemMod	EGT1 3684REFX RM	127	2641	4167
	36 x 84 Tilt w/RemMod	EGT1 3684RETL RM	132	3110	5108
	36 x 84 Tilt w/HangMod	EGT1 3684RETL HM	148	3110	5108

**To Order, Specify...**

- 1 Model Number
- 2 Top Material
- 3 Edge Style and Thickness
- 4 Edge Color
- 5 Base Color
- 6 Additional Options



**Base Options**

**Code Price**

Casters (4), Dual Wheel Black		
Hard Wheel (to 72" length).....	CAS55	\$ 171
Casters (4), Dual Wheel Black		
Soft Wheel (to 72" length).....	CAS57	\$ 171

**Finish Options**

Chrome .....		\$ 649
Nickel.....		\$ 710
Powder Coat, Standard .....		n/c
Powder Coat, Premium.....		\$ 165
Platinum.....		\$ 488

**Top Options**

Table Link (all four sides) .....	TLK	\$ 251
Table Link (36" ends only) .....	TLE	\$ 135
Special Laminate.....	TSP	call
Custom Cutout (per cutout) .....	TCC	\$ 120

**Power + Data Options**

Please reference the Power + Data Price List



**Wire Management Options**

1 Oval Brush Grommet, Location A .....	WOA	\$ 97
2 Oval Brush Grommets, Location E .....	WOE	\$ 194
1 Oval Brush Grommet, Provide Location Print. ....	WOG	\$ 97
1 Round Grommet, Location A .....	WRA	\$ 76
2 Round Grommets, Location E.....	WRE	\$ 152
1 Round Grommet, Provide Location Print .....	WRG	\$ 76



**Questions?**

800 876 2120

top >	Laminate PVC	Laminate Wood
edge >	Flat 	Flat 
edge ordering code (square corner) >	<b>LP7S</b>	<b>LW7S</b>
top thickness >	1"	1"
top thickness price >	1"	1"

Base Style	Table Description	Model #	Product Wt	1"	1"
 TI	36 x 90 Fix	<b>EGT1 3690REFX</b>	131	1978	3058
	36 x 90 Tilt	<b>EGT1 3690RETL</b>	136	2522	3547
	36 x 90 Fix w/FixMod	<b>EGT1 3690REFX XM</b>	153	3056	5081
	36 x 90 Fix w/RemMod	<b>EGT1 3690REFX RM</b>	135	3098	5128
	36 x 90 Tilt w/RemMod	<b>EGT1 3690RETL RM</b>	140	3654	5680
	36 x 90 Tilt w/HangMod	<b>EGT1 3690RETL HM</b>	158	3654	5680
	36 x 96 Fix	<b>EGT1 3696REFX</b>	138	2082	3248
	36 x 96 Tilt	<b>EGT1 3696RETL</b>	144	2637	3803
	36 x 96 Fix w/FixMod	<b>EGT1 3696REFX XM</b>	162	3056	5081
	36 x 96 Fix w/RemMod	<b>EGT1 3696REFX RM</b>	143	3098	5128
	36 x 96 Tilt w/RemMod	<b>EGT1 3696RETL RM</b>	149	3654	5680
	36 x 96 Tilt w/HangMod	<b>EGT1 3696RETL HM</b>	168	3654	5680

**Note:** Training tables are often used with lightweight computer accessories. For heavy duty applications, such as large scale computer equipment, multiple monitor mounts, etc., Versteel suggests adding a third leg or stretcher. The price of the 84", 90" and 96" models include a stretcher rail required for additional support. Contact Customer Service if you have specific application concerns or questions.

**To Order, Specify...**

- 1 Model Number
- 2 Top Material
- 3 Edge Style and Thickness
- 4 Edge Color
- 5 Base Color
- 6 Additional Options



**Finish Options**

Chrome .....	\$ 649
Nickel .....	\$ 710
Powder Coat, Standard .....	n/c
Powder Coat, Premium .....	\$ 165
Platinum .....	\$ 488

**Top Options**

Table Link (all four sides) .....	TLK	\$ 251
Table Link (36" ends only) .....	TLE	\$ 135
Special Laminate .....	TSP	call
Custom Cutout (per cutout) .....	TCC	\$ 120

**Power + Data Options**

Please reference the Power + Data Price List

**Wire Management Options**

1 Oval Brush Grommet, Location A .....	WOA	\$ 97
2 Oval Brush Grommets, Location E .....	WOE	\$ 194
1 Oval Brush Grommet, Provide Location Print. ....	WOG	\$ 97
1 Round Grommet, Location A .....	WRA	\$ 76
2 Round Grommets, Location E .....	WRE	\$ 152
1 Round Grommet, Provide Location Print .....	WRG	\$ 76



**Questions?**

800 876 2120

top > edge >	Laminate PVC	Laminate Wood
	Flat	Flat
edge ordering code (square corner) > top thickness >	<b>LP7S</b> 1"	<b>LW7S</b> 1"
top thickness price >	1"	1"

Base Style	Table Description	Model #	Product Wt	1"	1"
 TC	24 x 48 Fix	EGTC 2448REFX	55	1247	1697
	24 x 48 Slim-Tilt	EGTC 2448REST	64	1767	2217
	24 x 48 Fix w/FixMod	EGTC 2448REFX XM	68	1563	1602
	24 x 48 Fix w/RemMod	EGTC 2448REFX RM	57	1584	1652
	24 x 48 Slim-Tilt w/RemMod	EGTC 2448REST RM	66	2119	2170
	24 x 48 Slim-Tilt w/HangMod	EGTC 2448REST HM	77	2119	2170
	24 x 48 Fix w/FixLightweightFormMod	EGTC 2448REFX XL	67	1584	1652
	24 x 48 Fix w/RemLightweightFormMod	EGTC 2448REFX RL	67	1584	1652
	24 x 48 Fix w/FixFormMod	EGTC 2448REFX XF	77	1697	1754
	24 x 60 Fix	EGTC 2460REFX	63	1332	1894
	24 x 60 Slim-Tilt	EGTC 2460REST	75	1767	2217
	24 x 60 Fix w/FixMod	EGTC 2460REFX XM	78	1759	1836
	24 x 60 Fix w/RemMod	EGTC 2460REFX RM	66	1808	1886
	24 x 60 Slim-Tilt w/RemMod	EGTC 2460REST RM	78	2325	2398
	24 x 60 Slim-Tilt w/HangMod	EGTC 2460REST HM	90	2325	2398
	24 x 60 Fix w/FixLightweightFormMod	EGTC 2460REFX XL	78	1808	1886
	24 x 60 Fix w/RemLightweightFormMod	EGTC 2460REFX RL	78	1808	1886
	24 x 60 Fix w/FixFormMod	EGTC 2460REFX XF	90	2082	2158
	24 x 72 Fix	EGTC 2472REFX	70	1528	2134
	24 x 72 Slim-Tilt	EGTC 2472REST	85	2041	2655
	24 x 72 Fix w/FixMod	EGTC 2472REFX XM	87	2030	2095
	24 x 72 Fix w/RemMod	EGTC 2472REFX RM	74	2076	2143
	24 x 72 Slim-Tilt w/RemMod	EGTC 2472REST RM	89	2593	2662
	24 x 72 Slim-Tilt w/HangMod	EGTC 2472REST HM	102	2593	2662
24 x 72 Fix w/FixLightweightFormMod	EGTC 2472REFX XL	88	2079	2145	
24 x 72 Fix w/RemLightweightFormMod	EGTC 2472REFX RL	88	2079	2145	
24 x 72 Fix w/FixFormMod	EGTC 2472REFX XF	102	2273	2340	
24 x 84 Fix	EGTC 2484REFX	94	1611	2364	
24 x 84 Slim-Tilt	EGTC 2484REST	97	2128	2882	
24 x 84 Fix w/FixMod	EGTC 2484REFX XM	114	2280	2286	
24 x 84 Fix w/RemMod	EGTC 2484REFX RM	98	2309	2320	
24 x 84 Slim-Tilt w/RemMod	EGTC 2484REST RM	101	2843	4069	
24 x 84 Slim-Tilt w/HangMod	EGTC 2484REST HM	117	2843	4069	

**Note:** Slim-tilt tables, highlighted above, come standard with Versteel casters.

**Note:** Training tables are often used with lightweight computer accessories. For heavy duty applications, such as large scale computer equipment, multiple monitor mounts, etc., Versteel suggests adding a third leg or stretcher. The price of the 84", 90" and 96" models include a stretcher rail required for additional support. Contact Customer Service if you have specific application concerns or questions.

**To Order, Specify...**

- 1 Model Number
- 2 Top Material
- 3 Edge Style and Thickness
- 4 Edge Color
- 5 Base Color
- 6 Additional Options



**Base Options**

**Code Price**

Casters (4), Dual Wheel Black		
Hard Wheel (to 72" length).....	CAS55	\$ 171
Casters (4), Dual Wheel Black		
Soft Wheel (to 72" length).....	CAS57	\$ 171

**Finish Options**

Chrome .....		\$ 649
Nickel.....		\$ 710
Powder Coat, Standard .....		n/c
Powder Coat, Premium.....		\$ 165
Platinum.....		\$ 488

**Top Options**

Table Link (all four sides) .....	TLK	\$ 251
Table Link (24" ends only) .....	TLE	\$ 135
Special Laminate.....	TSP	call
Custom Cutout (per cutout) .....	TCC	\$ 120

**Power + Data Options**

Please reference the Power + Data Price List



**Wire Management Options**

1 Oval Brush Grommet, Location A .....	WOA	\$ 97
2 Oval Brush Grommets, Location E .....	WOE	\$ 194
1 Oval Brush Grommet, Provide Location Print. ....	WOG	\$ 97
1 Round Grommet, Location A .....	WRA	\$ 76
2 Round Grommets, Location E.....	WRE	\$ 152
1 Round Grommet, Provide Location Print .....	WRG	\$ 76



**Questions?**

800 876 2120

top >	Laminate PVC	Laminate Wood
edge >	Flat 	Flat 
edge ordering code (square corner) >	<b>LP7S</b>	<b>LW7S</b>
top thickness >	1"	1"
top thickness price >	1"	1"

Base Style	Table Description	Model #	Product Wt	1"	1"
 TC	24 x 90 Fix	<b>EGTC 2490REFX</b>	100	1742	2567
	24 x 90 Slim-Tilt	<b>EGTC 2490REST</b>	103	2269	3063
	24 x 90 Fix w/FixMod	<b>EGTC 2490REFX XM</b>	122	2762	4335
	24 x 90 Fix w/RemMod	<b>EGTC 2490REFX RM</b>	104	2880	3746
	24 x 90 Slim-Tilt w/RemMod	<b>EGTC 2490REST RM</b>	107	3395	4260
	24 x 90 Slim-Tilt w/HangMod	<b>EGTC 2490REST HM</b>	125	3395	4260
	24 x 96 Fix	<b>EGTC 2496REFX</b>	105	1862	2726
	24 x 96 Slim-Tilt	<b>EGTC 2496REST</b>	109	2378	3246
	24 x 96 Fix w/FixMod	<b>EGTC 2496REFX XM</b>	129	2762	4335
	24 x 96 Fix w/RemMod	<b>EGTC 2496REFX RM</b>	110	2880	3746
	24 x 96 Slim-Tilt w/RemMod	<b>EGTC 2496REST RM</b>	114	3395	4260
	24 x 96 Slim-Tilt w/HangMod	<b>EGTC 2496REST HM</b>	133	3395	4260

**Note:** Slim-tilt tables, highlighted above, come standard with Versteel casters.

**Note:** Training tables are often used with lightweight computer accessories. For heavy duty applications, such as large scale computer equipment, multiple monitor mounts, etc., Versteel suggests adding a third leg or stretcher. The price of the 84", 90" and 96" models include a stretcher rail required for additional support. Contact Customer Service if you have specific application concerns or questions.

**To Order, Specify...**

- 1 Model Number
- 2 Top Material
- 3 Edge Style and Thickness
- 4 Edge Color
- 5 Base Color
- 6 Additional Options



**Finish Options**

Chrome .....	\$ 649
Nickel .....	\$ 710
Powder Coat, Standard .....	n/c
Powder Coat, Premium .....	\$ 165
Platinum .....	\$ 488

**Top Options**

Table Link (all four sides) .....	TLK	\$ 251
Table Link (24" ends only) .....	TLE	\$ 135
Special Laminate .....	TSP	call
Custom Cutout (per cutout) .....	TCC	\$ 120

**Power + Data Options**

Please reference the Power + Data Price List

**Wire Management Options**



1 Oval Brush Grommet, Location A .....	WOA	\$ 97
2 Oval Brush Grommets, Location E .....	WOE	\$ 194
1 Oval Brush Grommet, Provide Location Print. ....	WOG	\$ 97
1 Round Grommet, Location A .....	WRA	\$ 76
2 Round Grommets, Location E .....	WRE	\$ 152
1 Round Grommet, Provide Location Print .....	WRG	\$ 76



**Questions?**

800 876 2120

top >  
edge >

Laminate PVC	Laminate Wood
Flat	Flat
	
edge ordering code (square corner) > top thickness >	
<b>LP7S</b> 1"	<b>LW7S</b> 1"
top thickness price >	
1"	1"

Base Style	Table Description	Model #	Product Wt	1"	1"
 TC	30 x 48 Fix	EGTC 3048REFX	63	1375	1846
	30 x 48 Slim-Tilt	EGTC 3048REST	75	1895	2364
	30 x 48 Fix w/FixMod	EGTC 3048REFX XM	76	1692	2364
	30 x 48 Fix w/RemMod	EGTC 3048REFX RM	66	1721	2381
	30 x 48 Slim-Tilt w/RemMod	EGTC 3048REST RM	78	2259	2936
	30 x 48 Slim-Tilt w/HangMod	EGTC 3048REST HM	88	2259	2936
	30 x 48 Fix w/FixLightweightFormMod	EGTC 3048REFX XL	75	1721	2381
	30 x 48 Fix w/RemLightweightFormMod	EGTC 3048REFX RL	75	1721	2775
	30 x 48 Fix w/FixFormMod	EGTC 3048REFX XF	85	1841	2345
	30 x 60 Fix	EGTC 3060REFX	73	1460	2065
	30 x 60 Slim-Tilt	EGTC 3060REST	87	1978	2581
	30 x 60 Fix w/FixMod	EGTC 3060REFX XM	88	1890	2875
	30 x 60 Fix w/RemMod	EGTC 3060REFX RM	76	1937	2920
	30 x 60 Slim-Tilt w/RemMod	EGTC 3060REST RM	90	2455	3439
	30 x 60 Slim-Tilt w/HangMod	EGTC 3060REST HM	102	2455	3439
	30 x 60 Fix w/FixLightweightFormMod	EGTC 3060REFX XL	88	1937	2919
	30 x 60 Fix w/RemLightweightFormMod	EGTC 3060REFX RL	88	1937	2919
	30 x 60 Fix w/FixFormMod	EGTC 3060REFX XF	100	2209	2816
	30 x 72 Fix	EGTC 3072REFX	83	1573	2283
	30 x 72 Slim-Tilt	EGTC 3072REST	100	2092	2798
	30 x 72 Fix w/FixMod	EGTC 3072REFX XM	100	2080	3497
	30 x 72 Fix w/RemMod	EGTC 3072REFX RM	87	2128	3541
	30 x 72 Slim-Tilt w/RemMod	EGTC 3072REST RM	104	2646	4058
	30 x 72 Slim-Tilt w/HangMod	EGTC 3072REST HM	117	2646	4058
	30 x 72 Fix w/FixLightweightFormMod	EGTC 3072REFX XL	101	2129	3542
	30 x 72 Fix w/RemLightweightFormMod	EGTC 3072REFX RL	101	2129	3542
	30 x 72 Fix w/FixFormMod	EGTC 3072REFX XF	115	2327	3035
	30 x 84 Fix	EGTC 3084REFX	109	1687	2576
	30 x 84 Slim-Tilt	EGTC 3084REST	114	2202	3092
	30 x 84 Fix w/FixMod	EGTC 3084REFX XM	129	2368	3765
	30 x 84 Fix w/RemMod	EGTC 3084REFX RM	113	2401	3788
	30 x 84 Slim-Tilt w/RemMod	EGTC 3084REST RM	118	2842	4654
	30 x 84 Slim-Tilt w/HangMod	EGTC 3084REST HM	134	2842	4654

**Note:** Slim-tilt tables, highlighted above, come standard with Versteel casters.

**Note:** Training tables are often used with lightweight computer accessories. For heavy duty applications, such as large scale computer equipment, multiple monitor mounts, etc., Versteel suggests adding a third leg or stretcher. The price of the 84", 90" and 96" models include a stretcher rail required for additional support. Contact Customer Service if you have specific application concerns or questions.

**To Order, Specify...**

- 1 Model Number
- 2 Top Material
- 3 Edge Style and Thickness
- 4 Edge Color
- 5 Base Color
- 6 Additional Options



**Base Options**

**Code Price**

Casters (4), Dual Wheel Black		
Hard Wheel (to 72" length).....	CAS55	\$ 171
Casters (4), Dual Wheel Black		
Soft Wheel (to 72" length).....	CAS57	\$ 171

**Finish Options**

Chrome .....		\$ 649
Nickel.....		\$ 710
Powder Coat, Standard .....		n/c
Powder Coat, Premium.....		\$ 165
Platinum.....		\$ 488

**Top Options**

Table Link (all four sides) .....	TLK	\$ 251
Table Link (30" ends only) .....	TLE	\$ 135
Special Laminate.....	TSP	call
Custom Cutout (per cutout) .....	TCC	\$ 120

**Power + Data Options**

Please reference the Power + Data Price List



**Wire Management Options**

1 Oval Brush Grommet, Location A .....	WOA	\$ 97
2 Oval Brush Grommets, Location E .....	WOE	\$ 194
1 Oval Brush Grommet, Provide Location Print. ....	WOG	\$ 97
1 Round Grommet, Location A .....	WRA	\$ 76
2 Round Grommets, Location E.....	WRE	\$ 152
1 Round Grommet, Provide Location Print .....	WRG	\$ 76



**Questions?**

800 876 2120

top >	Laminate PVC	Laminate Wood
edge >	Flat 	Flat 
edge ordering code (square corner) >	<b>LP7S</b>	<b>LW7S</b>
top thickness >	1"	1"
top thickness price >	1"	1"

Base Style	Table Description	Model #	Product Wt	1"	1"
 TC	30 x 90 Fix	<b>EGTC 3090REFX</b>	116	1800	2780
	30 x 90 Slim-Tilt	<b>EGTC 3090REST</b>	121	2309	3238
	30 x 90 Fix w/FixMod	<b>EGTC 3090REFX XM</b>	138	2776	4618
	30 x 90 Fix w/RemMod	<b>EGTC 3090REFX RM</b>	120	2819	4662
	30 x 90 Slim-Tilt w/RemMod	<b>EGTC 3090REST RM</b>	125	3336	5178
	30 x 90 Slim-Tilt w/HangMod	<b>EGTC 3090REST HM</b>	143	3336	5178
	30 x 96 Fix	<b>EGTC 3096REFX</b>	122	1894	2953
	30 x 96 Slim-Tilt	<b>EGTC 3096REST</b>	128	2412	3472
	30 x 96 Fix w/FixMod	<b>EGTC 3096REFX XM</b>	146	2776	4618
	30 x 96 Fix w/RemMod	<b>EGTC 3096REFX RM</b>	127	2819	4662
	30 x 96 Slim-Tilt w/RemMod	<b>EGTC 3096REST RM</b>	133	3336	5178
	30 x 96 Slim-Tilt w/HangMod	<b>EGTC 3096REST HM</b>	152	3336	5178

**Note:** Slim-tilt tables, highlighted above, come standard with Versteel casters.

**Note:** Training tables are often used with lightweight computer accessories. For heavy duty applications, such as large scale computer equipment, multiple monitor mounts, etc., Versteel suggests adding a third leg or stretcher. The price of the 84", 90" and 96" models include a stretcher rail required for additional support. Contact Customer Service if you have specific application concerns or questions.

**To Order, Specify...**

- 1 Model Number
- 2 Top Material
- 3 Edge Style and Thickness
- 4 Edge Color
- 5 Base Color
- 6 Additional Options



**Finish Options**

Chrome .....	\$ 649
Nickel .....	\$ 710
Powder Coat, Standard .....	n/c
Powder Coat, Premium .....	\$ 165
Platinum .....	\$ 488

**Top Options**

Table Link (all four sides) .....	TLK	\$ 251
Table Link (30" ends only) .....	TLE	\$ 135
Special Laminate .....	TSP	call
Custom Cutout (per cutout) .....	TCC	\$ 120

**Power + Data Options**

Please reference the Power + Data Price List

**Wire Management Options**

1 Oval Brush Grommet, Location A .....	WOA	\$ 97
2 Oval Brush Grommets, Location E .....	WOE	\$ 194
1 Oval Brush Grommet, Provide Location Print. ....	WOG	\$ 97
1 Round Grommet, Location A .....	WRA	\$ 76
2 Round Grommets, Location E .....	WRE	\$ 152
1 Round Grommet, Provide Location Print .....	WRG	\$ 76

All prices are delivered list price effective with date printed on cover and supersedes all other published price lists. Versteel reserves the right to change prices or specifications without prior notice. Orders are accepted subject to price prevailing at time of shipment.

**versteel.com**  
Made in America  
800 876 2120