

Proudly crafted in the USA.

# Seating

## 2025 Price List

[→ JUMP TO PRICING](#)



# VERSTEEL



Elly is a modular soft-seating series featuring oversized seats to accommodate multiple sitting styles and body shapes. Linking tables may be added to compliment or complete your configuration. When creating your space don't forget to include the Elly pull up table.

#### Seating

Seating frames are constructed of laminated plywood with CNC cut joints. The pocket and notch construction is reinforced with corner blocks. High density polyurethane foam with webbing is used for comfort.

Units are standard with a primary and accent fabric. The accent fabric is on the side of the seat and back, the front of the arms and the side of the bolster. The accent fabric is included in the cost of each unit. Contact Customer Service for list pricing if the accent fabric is higher than a grade 6. If an accent fabric isn't desired specify it to be the same as the primary fabric.

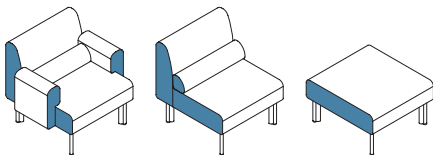

Component fastening points are metal to metal for ease of assembly and durability. The Paces style steel legs are welded to a mounting plate. Adjustable nylon glides are standard. All Versteel powder coats, including Chrome and Nickel are available.

#### Linking Tables

Elly linking tables are available in square, rectangle and half round shapes. Tops are 6 1/2" high and may be specified in laminate or veneer with a self edge. Available in all Versteel powder coats, including Chrome and Nickel, the steel legs are welded to mounting plates. Adjustable nylon glides are standard.

The Elly pull up table is perfect for a cup of coffee, personal electronic device, or anything you might want to keep close at hand. Available with either a laminate or veneer top with a 3/8" PVC or wood edge band the unique top shape is designed for comfort and use. The heavy-duty powder coated steel platform-style base features fixed nylon glides. Chrome and Nickel are not available on the pull up table.

#### Power/Data

A mini-tap electrical unit may be specified in the seats or tables. See the planning page for additional information.

#### BIFMA

All Versteel products are constructed to pass the relevant ANSI/BIFMA standards. For more detailed specifications by series and base style, contact Versteel Customer Service at 800.876.2120.

Additional information regarding warranty, terms and conditions, shipping, care and maintenance, etc. can be found in the All Seating price list.

**Standard Versteel Upholstery**

Standard Versteel Upholstery offers a range of materials, from fabrics in a variety of colors and textures to vinyl for soil resistance. Please refer to Versteel's fabric cards or the "Materials + Finishes" section of our website for reference information.

**Grade-In Upholstery**

Versteel has coordinated with upholstery manufacturers to simplify your order process. Many of the manufacturers' offerings have been pre-approved for application on Versteel Seating.

Contact Versteel Customer Service with your selected fabric choice to be graded in. They will supply you with the appropriate grade-in designator. On your purchase order, complete the information with the pattern name, color description and grade-in designator, and Versteel will take it from there.

**Customer's Own Material**

Customer's Own Materials (COM's) are not an issue on Elly. Many COM's are pre-approved for application on Versteel Seating. Call Versteel Customer Service with your COM selection to determine if it has been pre-approved. If your selection has not been pre-approved, reference the "Receiving COM Approval" section below.

**Receiving COM Approval**

Not all materials are suitable for upholstery on Elly. A 12" X 12" memo sample must be supplied for approval before a COM material is accepted for an order. If the material is directional in pattern or weave, the pattern repeat (in inches) in both directions or the weave direction must be supplied.

**Excess COM**

Versteel will not store excess COM for more than 30 days after the order has been completed. If excess material is to be returned after order completion, send the request to Versteel Customer Service prior to acknowledge ship date. It is the customer's responsibility to arrange for the return of the material "freight collect."

**COM Requiring Application Test**

If an application test is required for your selected COM, send test sample material along with the following:

- Name and return address
- Chair model selected
- Sketch showing special requirements for the positioning of the material's pattern on the chair seat and chair back, if special considerations are required.

**NOTE** ALL UPHOLSTERIES ARE CUT UP THE ROLL TO MAXIMIZE YIELD AND WEAR PERFORMANCE

**Ship COM to:**

Versteel  
2332 Cathy Lane  
Jasper, IN 47546

COM must be shipped to the factory with transportation costs "prepaid." If material is considered defective or unusable, it will be returned "transportation collect."

For standard lead time orders, tag fabric with purchase order number and identify with project number if possible.

**Application of Directional Fabrics**

Due to the upholstering process, some fabrics not considered directional by the supplier may be considered directional by Versteel.

All COM's are cut "up the roll" unless otherwise directed by the customer (see illustration below).

**EXAMPLE** PATTERN CUT "UP THE ROLL"

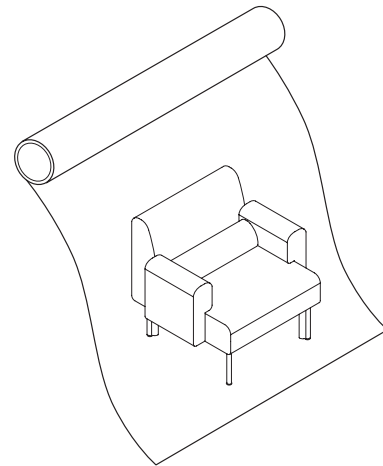

If special cutting or upholstery application is required, you must indicate requirement at time of order entry.

**Elly COM Yardage Requirements**

COM yardage requirements are calculated based on a material width of 54" and a repeat of 2" or less. For material less than 54" wide, contact Versteel for yardage requirements. Use the chart below as a guide to calculate your COM yardage. For quantities greater than 5, contact Versteel Customer Service for calculation of COM yardage by model.

Quantity of Units	1		2		3		4		5	
	Primary	Accent	Primary	Accent	Primary	Accent	Primary	Accent	Primary	Accent
<b>Chair</b>										
EY3229AN	5.5	1.5	10.0	3.0	14.0	4.0	17.0	5.0	21.0	6.0
EY3233AR	5.5	2.5	10.0	4.0	14.0	5.0	17.0	6.0	21.0	7.5
EY3233AL	5.5	2.5	10.0	4.0	14.0	5.0	17.0	6.0	21.0	7.5
EY3237AB	5.5	3.0	10.0	4.5	14.0	5.5	17.0	6.5	21.0	8.0
<b>Two Seat</b>										
EY3258AN	10.0	1.5	16.0	3.0	23.0	4.0	30.0	5.0	38.0	6.0
EY3262AR	10.0	2.5	16.0	4.0	23.0	5.0	30.0	6.0	38.0	7.5
EY3262AL	10.0	2.5	16.0	4.0	23.0	5.0	30.0	6.0	38.0	7.5
EY3266AB	10.0	3.0	16.0	4.5	23.0	5.5	30.0	6.5	38.0	8.0
<b>Three Seat</b>										
EY3287AN	13.5	2.0	24.0	3.5	34.5	4.5	45.0	5.5	62.5	6.5
EY3291AR	13.5	3.0	24.0	4.5	34.5	5.5	45.0	6.5	62.5	8.0
EY3291AL	13.5	3.0	24.0	4.5	34.5	5.5	45.0	6.5	62.5	8.0
EY3295AB	13.5	3.5	24.0	5.0	34.5	6.0	45.0	7.0	62.5	8.5
<b>Bench</b>										
EY3229BE1	2.5	1.0	4.0	1.5	5.0	1.5	6.5	2.0	7.5	2.0
EY3229BE2	4.0	1.5	6.5	2.0	9.0	2.5	11.5	3.0	14.0	4.0
EY3258BE1	5.0	2.0	8.0	3.0	10.0	3.0	13.0	4.0	15.0	4.0
EY3258BE2	8.0	3.0	13.0	4.0	18.0	5.0	23.0	6.0	28.0	8.0
EY3287BE1	7.5	3.0	12.0	4.5	15.0	4.5	19.5	6.0	22.5	6.0
EY3287BE2	12.0	4.5	19.5	6.0	27.0	7.5	34.5	9.0	42.0	12.0
<b>Bolster</b>										
EY0524BS	1.0	0.5	1.5	0.5	2.0	0.5	2.0	0.5	25.0	0.5
EY0526BS	1.5	0.5	2.0	0.5	3.0	0.5	3.5	0.5	40.0	0.5
EY0529BS	1.5	0.5	2.0	0.5	3.0	0.5	3.5	0.5	40.0	0.5

**Patterned COM Additional Yardage Guide**

Use the guide below to aid in ordering the appropriate COM fabric when needing to match a pattern with a repeat. To use this guide, add the vertical and horizontal repeats together (e.g. a 5" vertical repeat plus an 11" horizontal repeat gives a 16" total). Then find the appropriate entry on the chart, and increase the yardage estimate by the percentage indicated.

For example: The yardage estimate is 8 yards of 54" wide fabric and the pattern has a repeat of 11" horizontal and 5" vertical. Add up the repeats (11" + 5" = 16") and find the appropriate entry - 15% in this example. Fifteen percent more fabric is required to match the pattern. 8 yards plus an extra 15% is 9.2 yards.

Fabric Width	Plain Fabric	3" - 14" Repeat	15" - 19" Repeat	20" - 27" Repeat	28" - 36" Repeat	37" - 45" Repeat	46" - 54" Repeat
54"	0%	10%	15%	20%	25%	30%	35%
50" - 52"	10%	20%	25%	30%	35%	40%	45%

**Decorative Patterns**

Yardage requirements are greatly affected by the size of the repeat and the print or pattern of the material. Versteel cuts all seating patterns with aesthetic concerns in mind for high quality and consistency. Refer to the COM listing for the yardage required for pattern repeat.

**Repeats and Striped Fabrics**

The geometry of curved products prevents repeats and stripes from matching at the seams.

**Linking Configurations**

One, two and three seat units, benches and tables can be combined to create linking configurations for relaxation and collaboration.

When including a linking table in your configuration keep in mind it will need to link to an armless unit.

Elly offers two styles of backless benches: double sided and single sided. The single sided bench is not finished on the back and is intended for back-to-back application or to be placed against the wall.

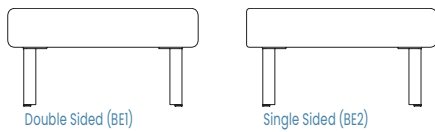

**Linking Tables**

There are three shapes of linking tables: square, rectangle and half round. All three shapes may be specified for the end of the configuration run. The square and rectangle tables may also be specified in the middle of a configuration. The square corner table is the perfect fit for corner applications.

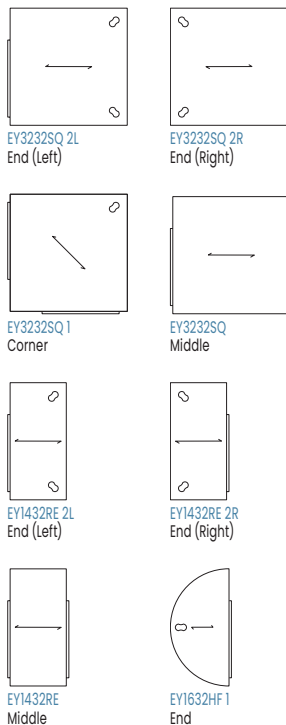

**Power**

It may be desirable to provide power access to your Elly configuration. The mini-tap is the perfect solution as it provides one outlet and one dual port USB charger. The unit is silver with white outlet trim.

On Elly seating, the mini-tap can be specified on either the lower right or left hand side of the seat cushion.

For linking tables the mini-tap is located opposite the leg on the front of square or rectangle end tables, and is centered on the front of rectangle middle tables. The mini-tap will be in the top surface when specified on corner and half round tables. For square middle tables there are two location options: one mini-tap centered on the front, or two mini-taps on either end of the front. See below for locations

**Seating**

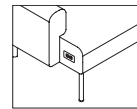

**Tables**

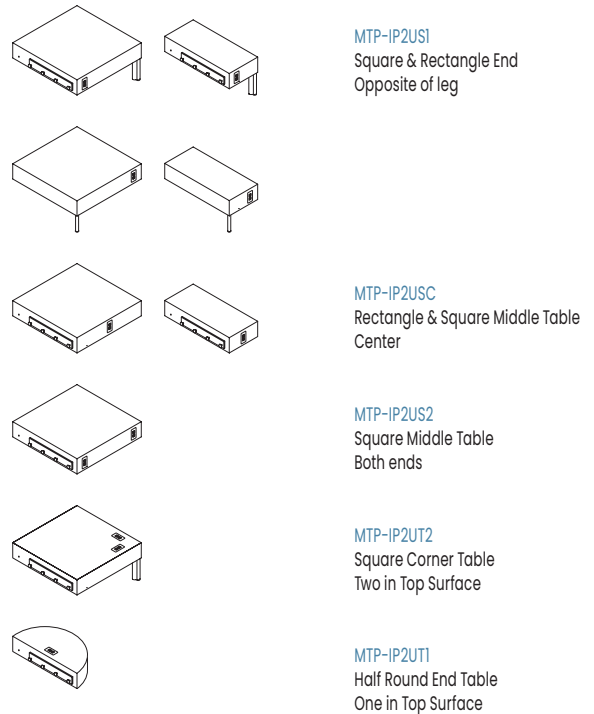

If you have particular needs that have not been addressed in this price list, please call Versteel Customer Service for answers and recommendations. A drawing of your layout is required for all Elly purchase orders.

**Configuration Examples**

Versteel will help with your configuration if you have concerns. Simply call Customer Service and provide the dimensions of your space and the type of configuration you desire. Like any other space planning, it is helpful to know where the power and data sources are, as well as windows, doors, any other obstructions and proposed traffic patterns.

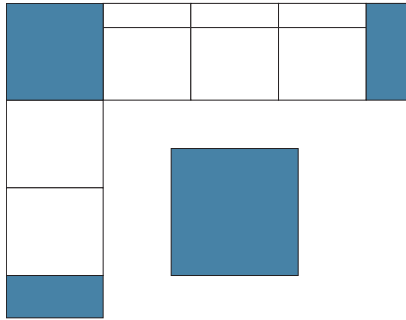

**L Configuration**

- (1) EY1432RE 2R
- (1) EY3258BEI
- (1) EY3232SQ 1
- (1) EY3287AN
- (1) OCEY16 42SQFX
- (1) EY1432RE 2L

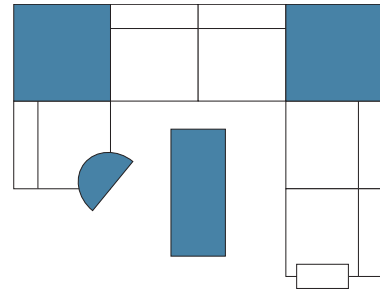

**U (Huddle) Configuration**

- (1) EY3229AN
- (2) EY3232SQ 1
- (1) EY3258AN
- (1) EY3262AL
- (1) EY1221LT
- (1) OCEY16 18842REFX

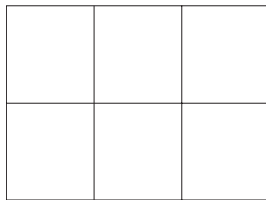

**Double-Sided Bench Configuration**

- (2) EY3287BE2

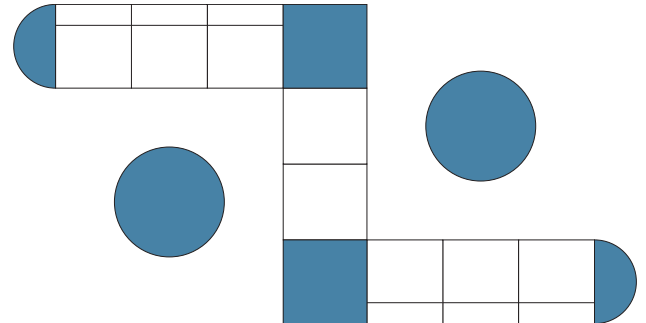

**Zig Zag Configuration**

- (2) EY1632HF 1
- (2) EY3287AN
- (2) EY3232SQ 1
- (1) EY3258BEI
- (2) OCEY16 42RDFX

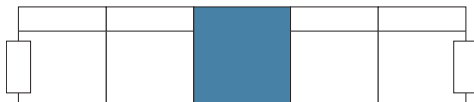

**In-Line Configuration**

- (1) EY3262AR
- (1) EY3232SQ
- (1) EY3262AL

**To Order, Specify...**

- 1 Model Number
- 2 Leg Color
- 3 Primary Upholstery Selection
- 4 Accent Upholstery Selection
- 5 Additional Options

model number	finish selections			additional options
<b>EY3295AB</b> <small>model number</small>	<b>PSIL</b> <small>leg color</small>	<b>FSL Cadet</b> <small>primary upholstery selection</small>	<b>FFM Sapphire</b> <small>accent upholstery selection</small>	<b>----</b> <small>additional options</small>

A **EY3295AB** is an Elly series, three seat with backs and arms.

The codes **PSIL / FSL Cadet / FFM Sapphire** specify Silver legs with Grade 4 Faux Mo Cadet upholstery and Grade 3 Solitaire Sapphire accent fabric.

**Model Number EY3295AB**



**NOTE** SAMPLE ORDER DOES NOT MATCH ABOVE IMAGE FABRICS AND FINISHES

**Orders may be sent via**

**Mailing Address**  
Versteel  
2332 Cathy Lane  
Jasper, IN 47546

**Contact Versteel**

**Email** contact@versteel.com  
**Phone** 800 876 2120  
812 634 2120



**Powder Coat Finishes**

All powder coat finishes in the Versteel offering have been formulated with the use of epoxy, polyester or epoxy and polyester blends to maximize the finish durability.

Powder Coat – Standard . . . . .n/c  
Powder Coat – Premium. . . . . \$165 per chair

**Elly Powder Coat Colors**

Alloy . . . . .	.PALY	Mint . . . . .	.PMNT
Amethyst . . . . .	.PAME	Navy . . . . .	.PNAV
Anthracite . . . . .	.PANT	Nimbus. . . . .	.PNIM
Black Anodized. . . . .	.PBLA	Nutmeg . . . . .	.PNUT
Bronze . . . . .	.PBRO	◆ Pacific . . . . .	.PPAC
Calypso . . . . .	.PCAL	Pearl . . . . .	.PPEA
Carbon . . . . .	.PCAR	Pebble . . . . .	.PPEB
Champagne . . . . .	.PCHA	Ⓟ Platinum . . . . .	.PPLA
Coconut . . . . .	.PCOC	Poppy. . . . .	.PPOP
◆ Copper. . . . .	.PCOP	◆ Raven. . . . .	.PRAV
Crimson . . . . .	.PCRI	Royal . . . . .	.PROY
◆ Crystal . . . . .	.PCRY	Seaside . . . . .	.PSEA
Daffodil. . . . .	.PDAF	Shipyards . . . . .	.PSHI
Ebony . . . . .	.PEBO	Silver . . . . .	.PSIL
Forest . . . . .	.PFOR	Snow . . . . .	.PSNO
Fossil . . . . .	.PFOS	Stone . . . . .	.PSTO
◆ Garnet . . . . .	.PGAR	Storm . . . . .	.PSTM
◆ Gold. . . . .	.PGOL	Terra Cotta . . . . .	.PTEC
Graphite . . . . .	.PGRA	Whisper . . . . .	.PWHI
Ⓟ Hope . . . . .	.PHOP	White Linen . . . . .	.PWHL
Kelly Green . . . . .	.PKEG	Powder Coat Alternative .	.OPA
◆ Matte . . . . .	.PMAT		
Mica. . . . .	.PMIC		

**Transparent Powder Coats (indicated by ◆)**

Please note that the transparent characteristics of these powders allow all natural welds and textures inherent to raw steel to be visible.

**Premium Powder Coats (indicated by Ⓟ)**

Versteel’s premium process uses specially formulated powder coats for a truly unique color palette.

**Plated**

Versteel offers two plated options: Chrome and Nickel. Chrome is our most durable finish available and is a deep luster chrome plated finish. Nickel is a plated finish with a clear coat applied for durability. An upcharge applies for plated finishes. See product pricing pages for upcharge.

Chrome . . . . . ECHR  
Nickel . . . . . ENKL

**Laminate**

Versteel’s standard offering of laminates includes over 900 laminates from Formica, Nevamar, Pionite and Wilsonart.

Laminate manufacturers change standard offerings frequently, making it possible a standard product can become unavailable. Versteel cannot be responsible for any inconvenience this may cause.

**Veneer**

Elly tables are available with standard Ash, Cherry, Maple and Walnut veneers.

**Standard Veneer Codes**

Ash . . . . . AP01  
Cherry . . . . . CP01  
Maple. . . . . MP01  
Walnut . . . . . WP01

**Veneer Finish Codes**

**Ash**

Beach. . . . . VBEA  
Chestnut. . . . . VCHE  
Drift . . . . . VDRI  
Fawn . . . . . VFAW  
Fog . . . . . VFOG  
Pebble . . . . . VPEB  
Whisper . . . . . VVHI

**Cherry**

Blossom Cherry . . . . . VBLC  
Cordovan Cherry . . . . . VCNC  
Golden Cherry . . . . . VGNC  
Java Cherry. . . . . VJAC  
Millwork Cherry. . . . . VMWC

**Maple**

Caramel Maple . . . . . VCMM  
Solar Maple. . . . . VSLM  
Sugar Maple . . . . . VSUM

**Walnut**

Brighton Walnut . . . . . VBRW  
Espresso Walnut. . . . . VESW  
Natural Walnut. . . . . VNAW

**Finish Reference & Samples**

For finish color reference, please refer to our website. Contact Versteel Customer Service to receive actual color samples for color matches and final color approval.

**Powder Coat Alternative**
**Call for quotation**

Specify code **OPA** (*Powder Coat Alternative*), add cost from Versteel quotation

Powder Coat Alternative is available from Versteel. The entire RAL color reference along with hundreds of other color and finishes are available.

For Powder Coat Alternative matching, you must supply a color reference sample, or an RAL number. Versteel will review the sample for possible existing colors available and send a sample for customer approval. If no color match exists a custom match can be developed. Call Versteel Customer Service for associated upcharges on custom color development.

**NOTE** CUSTOM COLOR MATCHING APPROVALS MAY AFFECT STANDARD PRODUCTION SCHEDULES

**Special Laminate**
**Call for quotation**

Specify code **TSP** (*Special Laminate*), indicate the quoted charges per table

Special laminates and patterns can be specified as an option. To specify, contact Versteel for availability and pricing.

**NOTE** LAMINATES IN STANDARD COLORS AND TEXTURES FROM FORMICA, NEVAMAR, PIONITE AND WILSONART ARE STANDARD

**CAUTION** LAMINATE MANUFACTURERS CHANGE STANDARD OFFERINGS FREQUENTLY, AND IT IS POSSIBLE THAT A STANDARD PRODUCT CAN BECOME UNAVAILABLE. VERSTEEL CANNOT BE RESPONSIBLE FOR ANY INCONVENIENCE THIS MAY CAUSE.

**Stain Finish Match**
**\$996 / one time charge per finish, per order**

Specify code **OSM** (*Stain Finish Match*), add \$996.00 list per finish, per order

Alternative Stain Finishes are available for veneer and wood edged tops.

For Stain Finish Matching you must supply two 4" x 4" finish color and grain reference samples. An expertly finish matched sample will be provided for customer approval.

**NOTE** CUSTOM COLOR MATCHING APPROVALS MAY AFFECT STANDARD PRODUCTION SCHEDULES

**Wood Finish Alternatives**

Versteel finish has a natural grain fill level finish appearance, contact Versteel Customer Service for alternative fill levels. Coarse grain will require additional application steps for a full-fill grain appearance and will require a quote.

**NOTE** WOOD FINISH ALTERNATIVE APPROVAL MAY AFFECT STANDARD PRODUCTION SCHEDULES

**Tablet Option**

A tablet can be specified at the beginning or the end of a run. It can be specified on units with or without arms or backs and/or electrical. Tablet cannot be used next to a table or another upholstered unit. The swivel tablet is 10" x 14". Surface is black laminate with a clear coated exposed plywood edge.

Specify code **BTBR** (right) or **BTBL** (left) and add \$324 list each.

**Planter**

A stainless steel planter box can be specified on any linking table without an electrical unit. Inside dimensions are 6" long x 5.4" wide x 5.9" deep. See below for planter locations.

Specify code **EYPBY6** and add \$198 list each

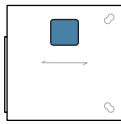

EY3232SQ 2L  
End (Left)

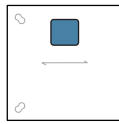

EY3232SQ 2R  
End (Right)

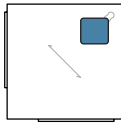

EY3232SQ 1  
Corner

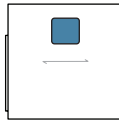

EY3232SQ  
Middle

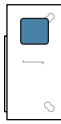

EY1432RE 2L  
End (Left)

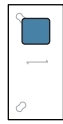

EY1432RE 2R  
End (Right)

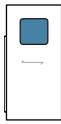

EY1432RE  
Middle

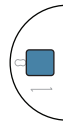





EY1632HF 1  
End



## Questions?

800 876 2120

material / fabric grade &gt;

	Description	Model#	Product Wt	Dimensions	2/COM	3	4	5	6	
	<b>Armless</b> Seat: Upholstered Back: Upholstered	<b>EY2929AN</b>	41	Overall Height: 33¾" Overall Width: 28¾" Overall Depth: 29"	Seat Height: 17½" Seat Width: 28¾" Seat Depth: 21"	2495	3038	3582	4124	4667
	<b>Arm - Right</b> Seat: Upholstered Back: Upholstered Arm: Upholstered	<b>EY2933AR</b>	49	Overall Height: 33¾" Overall Width: 33" Overall Depth: 29"	Seat Height: 17½" Seat Width: 28¾" Seat Depth: 21"	2959	3651	4348	5043	5736
	<b>Arm - Left</b> Seat: Upholstered Back: Upholstered Arm: Upholstered	<b>EY2933AL</b>	49	Overall Height: 33¾" Overall Width: 33" Overall Depth: 29"	Seat Height: 17½" Seat Width: 28¾" Seat Depth: 21"	2959	3651	4348	5043	5736
	<b>Arms</b> Seat: Upholstered Back: Upholstered Arms: Upholstered	<b>EY2937AB</b>	57	Overall Height: 33¾" Overall Width: 36¾" Overall Depth: 29"	Seat Height: 17½" Seat Width: 28¾" Seat Depth: 21"	3420	4267	5113	5960	6807



**Note:** Contact Customer Service for quote if accent fabric is higher than a grade 6.

**COM Yardage**  
Refer to page 94.

## To Order, Specify...

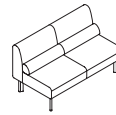
- 1 Model Number
- 2 Leg Color
- 3 Primary Upholstery Selection
- 4 Accent Upholstery Selection
- 5 Additional Options

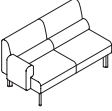

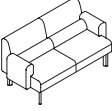
						material / fabric grade >				
						2/COM	3	4	5	6
Description	Model#	Product Wt	Dimensions							
 <b>Armless</b> Seat: Upholstered Back: Upholstered	<b>EY2958AN</b>	78	Overall Height: 33¾" Overall Width: 57½" Overall Depth: 29"	Seat Height: 17½" Seat Width: 28¾" Seat Depth: 21"		4581	5666	6751	7837	8924
 <b>Arm - Right</b> Seat: Upholstered Back: Upholstered Arm: Upholstered	<b>EY2962AR</b>	86	Overall Height: 33¾" Overall Width: 61¼" Overall Depth: 29"	Seat Height: 17½" Seat Width: 28¾" Seat Depth: 21"		5043	6281	7517	8755	9993
 <b>Arm - Left</b> Seat: Upholstered Back: Upholstered Arm: Upholstered	<b>EY2962AL</b>	86	Overall Height: 33¾" Overall Width: 61¼" Overall Depth: 29"	Seat Height: 17½" Seat Width: 28¾" Seat Depth: 21"		5043	6281	7517	8755	9993
 <b>Arms</b> Seat: Upholstered Back: Upholstered Arms: Upholstered	<b>EY2966AB</b>	96	Overall Height: 33¾" Overall Width: 65" Overall Depth: 29"	Seat Height: 17½" Seat Width: 28¾" Seat Depth: 21"		5504	6894	8284	9674	11063

**Note:** Contact Customer Service for quote if accent fabric is higher than a grade 6.

**COM Yardage**  
Refer to page 94.

Finish Options	Price
Chrome .....	\$ 165
Nickel .....	\$ 223
Powder Coat - Standard .....	n/c
Powder Coat - Premium .....	\$ 165

Power + Data Options	Code	Price
Mini-Tap (Right) .....	.MTP-IP2USR	\$ 531
Mini-Tap (Left) .....	.MTP-IP2USL	\$ 531
Mini-Tap (Right & Left) .....	.MTP-IP2USB	\$ 1062

Custom Charges	Code	Price
Powder Coat Alternative (per color) .....	.OPA	call

Tablet Options	Code	Price
Tablet (Right) .....	.BTBR	\$ 324
Tablet (Left) .....	.BTBL	\$ 324

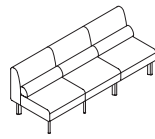

**Questions?**

800 876 2120

material / fabric grade >

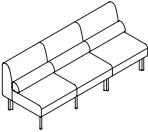
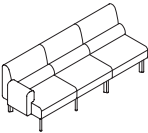
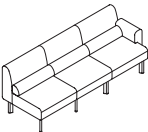
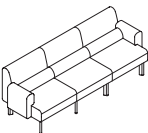
	Description	Model#	Product Wt	Dimensions	2/COM	3	4	5	6	
	<b>Armless</b> Seat: Upholstered Back: Upholstered	<b>EY2987AN</b>	115	Overall Height: 33¾" Overall Width: 86¼" Overall Depth: 29"	Seat Height: 17½" Seat Width: 28¾" Seat Depth: 21"	6749	8378	10006	11634	13265
	<b>Arm - Right</b> Seat: Upholstered Back: Upholstered Arm: Upholstered	<b>EY2991AR</b>	123	Overall Height: 33¾" Overall Width: 90¾" Overall Depth: 29"	Seat Height: 17½" Seat Width: 28¾" Seat Depth: 21"	7212	8992	10773	12552	14334
	<b>Arm - Left</b> Seat: Upholstered Back: Upholstered Arm: Upholstered	<b>EY2991AL</b>	123	Overall Height: 33¾" Overall Width: 90¾" Overall Depth: 29"	Seat Height: 17½" Seat Width: 28¾" Seat Depth: 21"	7212	8992	10773	12552	14334
	<b>Arms</b> Seat: Upholstered Back: Upholstered Arms: Upholstered	<b>EY2995AB</b>	131	Overall Height: 33¾" Overall Width: 93¾" Overall Depth: 29"	Seat Height: 17½" Seat Width: 28¾" Seat Depth: 21"	7673	9606	11537	13471	15403



**Note:** Contact Customer Service for quote if accent fabric is higher than a grade 6.

**COM Yardage**  
Refer to page 94.

**To Order, Specify...**

- 1 Model Number
- 2 Leg Color
- 3 Primary Upholstery Selection
- 4 Accent Upholstery Selection
- 5 Additional Options

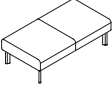
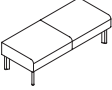
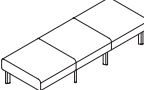
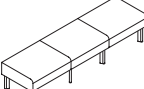

						material / fabric grade >				
						2/COM	3	4	5	6
	Description	Model#	Product Wt	Dimensions						
	<b>One Seat Bench</b> Seat: Upholstered NOTE: Makes one double sided row	EY2929BE1	15	Overall Height: 17½" Overall Width: 28¾" Overall Depth: 29"	Seat Height: 17½" Seat Width: 28¾" Seat Depth: 29"	1385	1556	1731	1904	2078
	<b>One Seat Bench</b> Seat: Upholstered NOTE: Back to back application	EY2129BE2	15	Overall Height: 17½" Overall Width: 28¾" Overall Depth: 21"	Seat Height: 17½" Seat Width: 28¾" Seat Depth: 21"	1385	1556	1731	1904	2078
	<b>Two Seat Bench</b> Seat: Upholstered NOTE: Makes one double sided row	EY2958BE1	44	Overall Height: 17½" Overall Width: 57½" Overall Depth: 29"	Seat Height: 17½" Seat Width: 28¾" Seat Depth: 29"	2470	2808	3148	3488	3826
	<b>Two Seat Bench</b> Seat: Upholstered Note: back to back application	EY2158BE2	35	Overall Height: 17½" Overall Width: 57½" Overall Depth: 21"	Seat Height: 17½" Seat Width: 28¾" Seat Depth: 21"	2470	2808	3148	3488	3826
	<b>Three Seat Bench</b> Seat: Upholstered Note: Makes one double sided row	EY2987BE1	64	Overall Height: 17½" Overall Width: 86¼" Overall Depth: 29"	Seat Height: 17½" Seat Width: 28¾" Seat Depth: 29"	3614	4127	4639	5153	5665
	<b>Three Seat Bench</b> Seat: Upholstered NOTE: back to back application	EY2187BE2	53	Overall Height: 17½" Overall Width: 86¼" Overall Depth: 21"	Seat Height: 17½" Seat Width: 28¾" Seat Depth: 21"	3614	4127	4639	5153	5665

**Note:** Contact Customer Service for quote if accent fabric is higher than a grade 6.

**COM Yardage**  
Refer to page 94.

Finish Options	Price
Chrome .....	\$ 165
Nickel .....	\$ 223
Powder Coat - Standard .....	n/c
Powder Coat - Premium .....	\$ 165

Power + Data Options	Code	Price
Mini-Tap (Right) .....	.MTP-IP2USR	\$ 531
Mini-Tap (Left) .....	.MTP-IP2USL	\$ 531
Mini-Tap (Right & Left) .....	.MTP-IP2USB	\$ 1062

Custom Charges	Code	Price
Powder Coat Alternative (per color) .....	.OPA	call

Tablet Options	Code	Price
Tablet (Right) .....	.BTBR	\$ 324
Tablet (Left) .....	.BTBL	\$ 324



**Questions?**

800 876 2120

top >  
edge >

Laminate Self Edge	Veneer Self Edge
-----------------------	---------------------







**LL9**

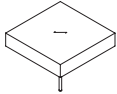
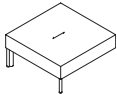

**VV9**

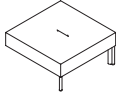
edge ordering code

	Description	Model#	Product Wt	Dimensions	2613	2769
	<b>Square</b> Middle Table No Legs	EY2929SQ	52	Height: 16½" Width: 29" Depth: 29"	2613	2769
	<b>Square</b> Corner Table Diagonal Grain One Leg	EY2929SQ 1	52	Height: 16½" Width: 29" Depth: 29"	2613	2769
 	<b>Square</b> End Table (Right) Two Legs	EY2929SQ 2R	52	Height: 16½" Width: 29" Depth: 29"	2613	2769
 	<b>Square</b> End Table (Left) Two Legs	EY2929SQ 2L	52	Height: 16½" Width: 29" Depth: 29"	2613	2769

**To Order, Specify...**

- 1 Model Number
- 2 Top Material
- 3 Top Color
- 4 Edge Detail
- 5 Leg Color
- 6 Additional Options



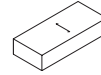

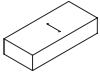
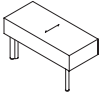
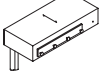
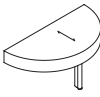
					top > edge >	Laminate Self Edge	Veneer Self Edge
					edge ordering code >	LL9	VV9
	Description	Model#	Product Wt	Dimensions			
	<b>Rectangle</b> Middle Table No Legs	EY1429RE	29	Height: 16½" Width: 14" Depth: 29"	2380	2392	
	<b>Rectangle</b> End Table (Right) Two Legs	EY1429RE 2R	29	Height: 16½" Width: 14" Depth: 29"	2380	2392	
	<b>Rectangle</b> End Table (Left) Two Legs	EY1429RE 2L	29	Height: 16½" Width: 14" Depth: 29"	2380	2392	
	<b>Half Round</b> End Table One Leg	EY1629HF1	15	Height: 16½" Width: 15½" Depth: 29"	2686	2556	

Finish Options	Price
Chrome .....	\$ 165
Nickel .....	\$ 223
Powder Coat - Standard .....	n/c
Powder Coat - Premium .....	\$ 165

Power + Data Options	Code	Price
Mini-Tap .....	MTP-IP2USC	\$ 531
Mini-Tap .....	MTP-IP2UT2	\$ 1062
Mini-Tap .....	MTP-IP2US1	\$ 531
Mini-Tap .....	MTP-IP2US2	\$ 1062
Mini-Tap .....	MTP-IP2UT1	\$ 531



Custom Charges	Code	Price
Powder Coat Alternative (per color) .....	OPA	call
Stain Finish Match (per finish) .....	OSM	\$ 996

Refer to page 106 for location information

Planter Options	Code	Price
Planter .....	EYPBY6	\$ 198



**Questions?**  
800 876 2120

Description	Model#	Product Wt	Dimensions	top thickness >	
				Laminate PVC	Veneer Wood
 Pull Up Table	EY2929SQ	21	Height: 25" Width: 21" Depth: 12"	top > edge >  edge ordering code <b>LPIR</b>	top > edge >  edge ordering code <b>VWIR</b>
				7/8"	7/8"
				375	1206

- To Order, Specify...**
- 1 Model Number
  - 2 Top Material
  - 3 Top Color
  - 4 Edge Detail
  - 5 Leg Color
  - 6 Additional Options

---

<b>Finish Options</b>	<b>Price</b>
Powder Coat, Standard .....	n/c
Powder Coat - Premium.....	\$ 165

<b>Custom Charges</b>	<b>Code</b>	<b>Price</b>
Powder Coat Alternative (per color) .....	OPA	call
Stain Finish Match (per finish).....	OSM	\$ 996

All prices are delivered list price effective with date printed on cover and supersedes all other published price lists. Versteel reserves the right to change prices or specifications without prior notice. Orders are accepted subject to price prevailing at time of shipment.

**versteel.com**  
Made in America  
800 876 2120