

Price List

JUMP TO PRICING [CLICK HERE](#)

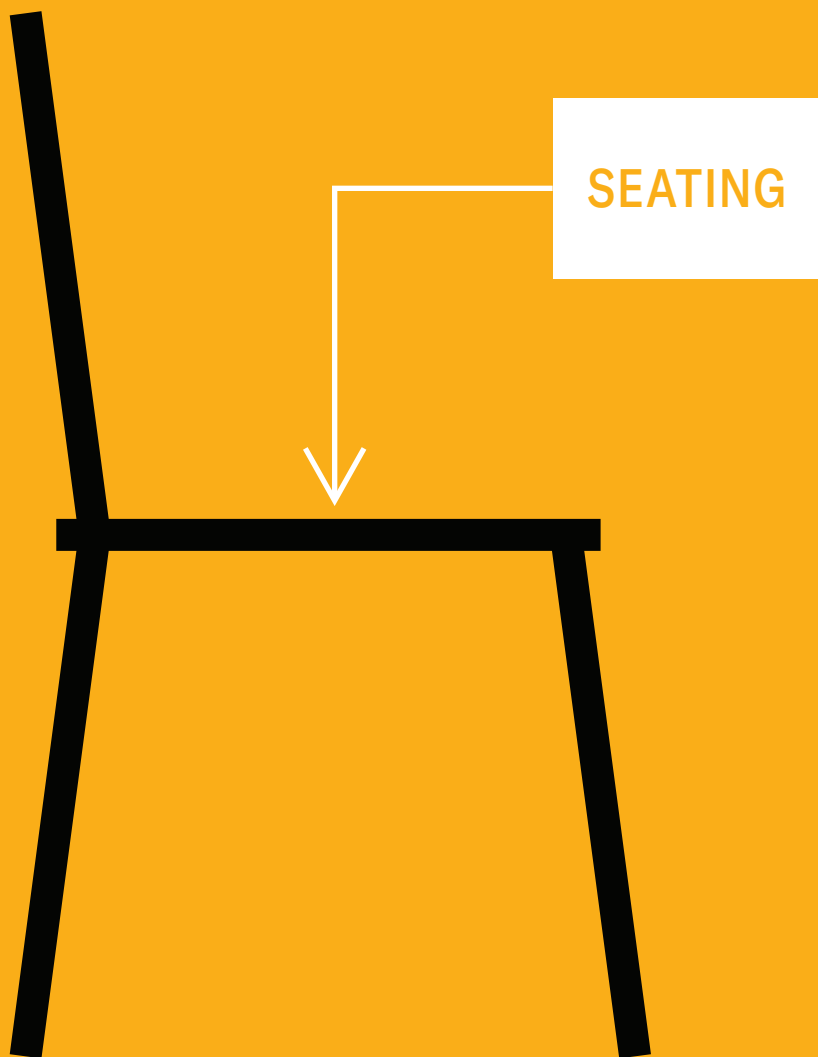

VERSTEEL



Catwalk is a modular soft-seating series featuring low, mid and high ledge heights that allow you to create endless configurations. Ledges may be specified in laminate, veneer or upholstery.

Features

The seat height for all catwalk units is 17 ½" tall. The unit to unit connection points for all seating models, along with same cushion dimensions, allow for easy configuration changes in the field.

Legs

Legs are 1 ¼" diameter steel tube with adjustable nylon glides.

Cat's Paw™

Every Catwalk unit is shipped with Cat's Paw linking brackets to ensure units remain connected in desired configuration. This unique design requires no tools to link units, and allows the brackets to remain on the unit when not in use.

Connector Tops

Two connector tops: rectangle and wedge may be specified to be linked to any catwalk upholstered unit. Available in laminate or veneer, these tops must be used between two units. They cannot be used at the beginning or an end of a run.

Power

If you desire USB charging the Salt unit is a perfect solution offering three different charging options. The Pepper unit is available when a power outlet is required. Additional information can be found on page 14.

Shipping Schedule

Standard Items

Fully Upholstered	4-5 WEEKS
Laminate, PVC Edge	4-5 WEEKS
Laminate, Wood Edge	4-5 WEEKS
Veneer, Wood Edge	6-8 WEEKS

Contact Versteel for special lead time requests.

BIFMA

All Versteel products are constructed to pass the relevant ANSI/BIFMA standards. For more detailed specifications by series and base style, contact Versteel Customer Service at 800.876.2120.

Additional information regarding warranty, terms and conditions, shipping, care and maintenance, etc. can be found in the All Seating price list.

Standard Versteel Upholstery

Standard Versteel Upholstery offers a range of materials, from fabrics in a variety of colors and textures to vinyls for soil resistance. Please refer to Versteel's fabric cards or the "Materials + Finishes" section of our website for information.

Grade-In Upholstery

Versteel has coordinated with upholstery manufacturers to simplify your order process. Many of the manufacturers' offerings have been pre-approved for application on Versteel Seating.

Contact Versteel Customer Service with your selected fabric choice to be graded in. You will be supplied with the appropriate grade-in designator. On your purchase order, complete the information with the pattern name, color description and grade-in designator, and Versteel will take it from there.

Customer's Own Material

Customer's Own Materials (COM's) are not an issue on Catwalk. Many COM's are pre-approved for application on Versteel Seating. Call Versteel Customer Service with your COM selection to determine if it has been pre-approved. If your selection has not been pre-approved, reference the "Receiving COM Approval" section below.

Receiving COM Approval

Not all materials are suitable for upholstery on Catwalk. A 12" x 12" memo sample must be supplied for approval before a COM material is accepted for an order. If the material is directional in pattern or weave, the pattern repeat (in inches) in both directions or the weave direction must be supplied.

Excess COM

Versteel will not store excess COM for more than 30 days after the order has been completed. If excess material is to be returned after order completion, send the request to Versteel Customer Service prior to acknowledged ship date. It is the customer's responsibility to arrange for the return of the material "freight collect."

COM Requiring Application Test

If an application test is required for your selected COM, send test sample material along with the following.

1. Name and return address
2. Model selected
3. Sketch showing special requirements for the positioning of the materials' pattern on the seat and ledge, if special considerations are required.

NOTE ALL UPHOLSTERIES ARE CUT UP THE ROLL TO MAXIMIZE YIELD AND WEAR PERFORMANCE

Ship COM to:

Versteel
2332 Cathy Lane
Jasper, IN 47546

COM must be shipped to the factory with transportation costs "prepaid." If material is considered defective or unusable, it will be returned "transportation collect."

For standard lead time orders, tag fabric with purchase order number and identify with project number if possible.

Application of Directional Fabrics

Due to the upholstering process, some fabrics not considered directional by the supplier may be considered directional by Versteel.

All COM's are cut "up the roll" unless otherwise directed by the customer (see illustration below).

EXAMPLE PATTERN CUT "UP THE ROLL"

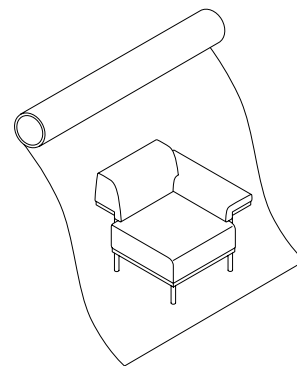

If special cutting or upholstery application is required, you must indicate requirement at time of order entry.

Catwalk COM Yardage Requirements

COM yardage requirements are calculated based on a material width of 54" and a repeat of 2" or less. For material less than 54" wide, contact Versteel for yardage requirements. Use the chart below as a guide to calculate your COM yardage. The "Same" column is for those units that are specified with the same fabric on the seat and the ledge. For quantities greater than 6, contact Versteel Customer Service for calculation of COM yardage by model.

Quantity of Units	1			2			3			4			5			6		
	Seat	Ledge	Same	Seat	Ledge	Same	Seat	Ledge	Same	Seat	Ledge	Same	Seat	Ledge	Same	Seat	Ledge	Same
Single																		
w/Ledge	2.0			3.0			4.0			5.0			6.0			6.5		
w/Low Bumper Ledge	2.0	1.0	2.0	3.0	1.5	3.5	4.0	1.5	5.0	5.0	1.5	6.0	6.0	2.0	7.0	6.5	2.5	8.0
w/Low Padded Ledge	2.0	1.0	3.0	3.0	2.0	5.0	4.0	2.0	6.0	5.0	2.5	7.5	6.0	3.0	9.0	6.5	3.5	10.0
w/Mid Padded Ledge	2.0	1.5	3.5	3.0	2.0	5.0	4.0	2.5	6.5	5.0	3.5	8.5	6.0	3.5	9.5	6.5	4.5	11.0
w/High Padded Ledge	2.0	1.5	3.5	3.0	2.5	5.5	4.0	3.0	7.0	5.0	4.0	9.0	6.0	4.5	10.5	6.5	5.5	12.0
Corner																		
w/Ledge	2.0			3.0			4.0			5.0			6.0			6.5		
w/Low Bumper Ledge	2.0	1.5	3.5	3.0	1.5	4.5	4.0	2.5	6.5	5.0	3.0	8.0	6.0	3.5	9.5	6.5	4.0	10.5
w/Low Padded Ledge	2.0	2.0	4.0	3.0	3.5	6.5	4.0	5.0	9.0	5.0	6.0	11.0	6.0	7.5	13.5	6.5	9.0	15.5
w/Mid Padded Ledge	2.0	3.0	5.0	3.0	4.5	7.5	4.0	6.0	10.0	5.0	8.0	13.0	6.0	9.5	15.5	6.5	11.0	17.5
w/High Padded Ledge	2.0	3.5	5.5	3.0	5.5	8.5	4.0	7.5	11.5	5.0	9.5	14.5	6.0	11.5	17.5	6.5	13.5	20.0
End																		
w/Low Pad Ledge + Mid Padded Ledge	2.0	2.5	4.5	3.0	3.5	6.5	4.0	5.0	9.0	5.0	5.5	10.5	6.0	7.0	13.0	6.5	8.0	14.5
w/Low Pad Ledge + High Padded Ledge	2.0	2.5	4.5	3.0	4.0	7.0	4.0	5.5	9.5	5.0	6.5	11.5	6.0	8.0	14.0	6.5	9.5	16.0
Split Level																		
w/Top	2.0			3.0			4.0			5.0			6.0			6.5		
w/Low Padded Top	2.0	2.0	4.0	3.0	3.5	6.5	4.0	4.0	8.0	5.0	5.5	10.5	6.0	5.5	11.5	6.5	7.5	14.0
w/Mid Padded Top	2.0	2.0	4.0	3.0	4.0	7.0	4.0	5.0	9.0	5.0	6.5	11.5	6.0	7.5	13.5	6.5	9.5	16.0
Bridge Models																		
w/Top	3.0			5.0			6.5			8.5			11.5			13.5		
w/Low Padded Top	3.0	2.0	5.0	5.0	3.5	8.5	6.5	4.0	10.5	8.5	5.5	14.0	11.5	5.5	17	13.5	7.5	21.0
w/Mid Padded Top	3.0	2.0	5.0	5.0	4.0	9.0	6.5	5.0	14.5	8.5	6.5	15.0	11.5	7.5	19	13.5	9.5	23.0
Ottoman																		
Seat Only	2.0			3.0			4.0			5.0			6.0			6.5		

Patterned COM Additional Yardage Guide

Use the guide below to aid in ordering the appropriate COM fabric when needing to match a pattern with a repeat. To use this guide, add the vertical and horizontal repeats together (e.g. a 5" vertical repeat plus an 11" horizontal repeat gives a 16" total). Then find the appropriate entry on the chart, and increase the yardage estimate by the percentage indicated.

For example: The yardage estimate is 8 yards of 54" wide fabric and the pattern has a repeat of 11" horizontal and 5" vertical. Add up the repeats (11" + 5" = 16") and find the appropriate entry - 15% in this example. Fifteen percent more fabric is required to match the pattern. 8 yards plus an extra 15% is 9.2 yards.

Fabric Width	Plain Fabric	3" - 14" Repeat	15" - 19" Repeat	20" - 27" Repeat	28" - 36" Repeat	37" - 45" Repeat	46" - 54" Repeat
54"	0%	10%	15%	20%	25%	30%	35%
50" - 52"	10%	20%	25%	30%	35%	40%	45%

Decorative Patterns

Yardage requirements are greatly affected by the size of the repeat and the print or pattern of the material. Versteel cuts all seating patterns with aesthetic concerns in mind for high quality and consistency. Refer to the COM listing for the yardage required for pattern repeat.

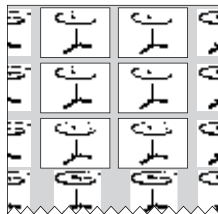

Linking Configurations

All Catwalk models can be combined to create configurations for relaxation, studying, collaboration, etc. Mix and match different ledge heights and styles along with the ottoman or one of the connector tops. When using a connector top keep in mind it must be used between non-ledge sides of two units.

Configuration Examples

Versteel will help you with your configuration if you have concerns. Simply call Customer Service and provide the dimensions of your space and the type of configuration you desire. Like any other space planning, it is helpful to know where the power sources are, as well as windows, doors and other obstructions and proposed traffic patterns.

Shown below and on the following pages are some idea starters. Units are priced with a powder coat frame, grade 2/COM fabric, laminate ledge and PVC edge.

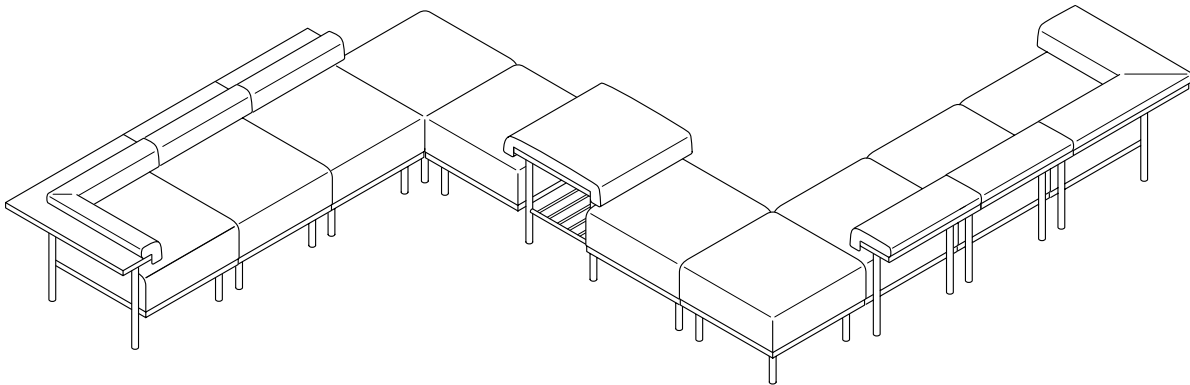
**Zig Zag Configuration**

- (1) CW3030 L02LP
- (2) CW2430 L02LP
- (2) CW2424
- (1) CW2466 L03P
- (2) CW2431 L03P
- (1) CW3131 L03P

Total List: \$23,042

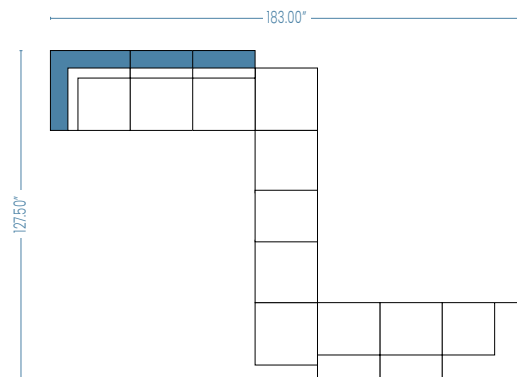

U Configuration

- (2) CW2424
- (2) CW2431 L03P
- (2) CW3131 M03P
- (2) CW2431 M03P
- (1) CW1223RE

Total List: \$20,981

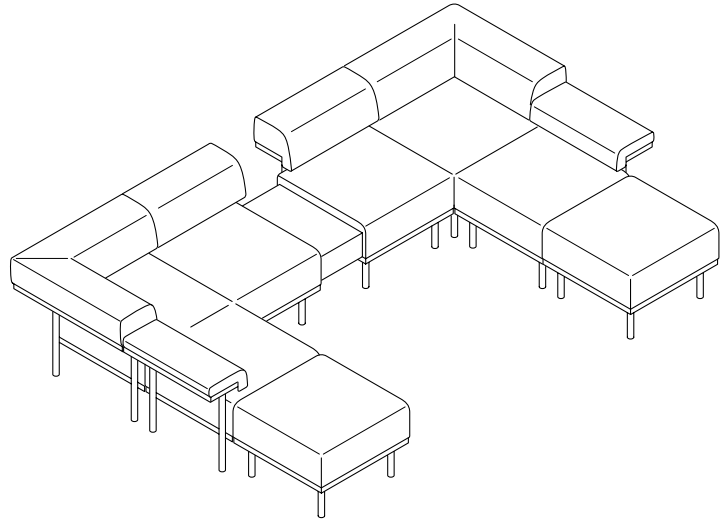
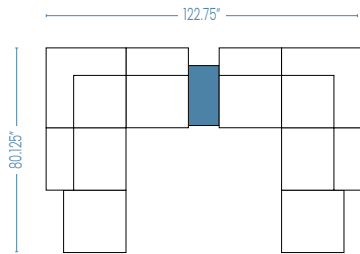

Conversation Configuration

- (2) CW3131 H03P
- (1) CW1223RE

Total List: \$7,979

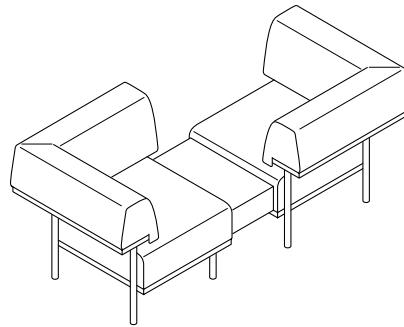
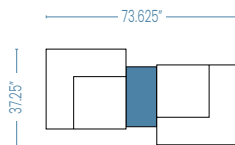

Sofa Configuration

- (1) CW3131 LRHB03P
- (1) CW2431 H03P
- (1) CW3131 LLHB03P

Total List: \$8,905

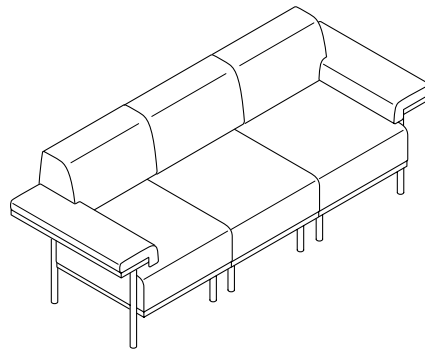
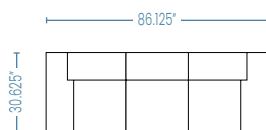

Chaise Configuration

- (2) CW2424
- (2) CW3131 LRMB03P
- (1) CW1223RE

Total List: \$11,023

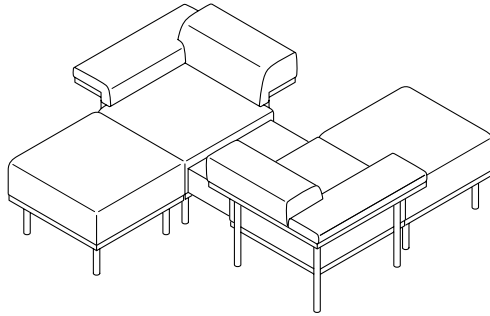
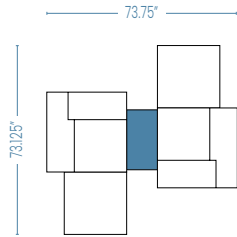

Offset Inline Configuration

- (2) CW3131 M03P
- (2) CW2424
- (2) CW2446 M03P

Total List: \$16,420

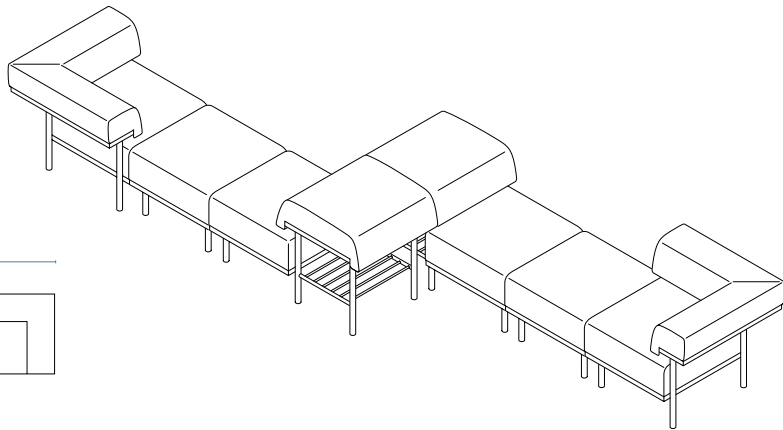
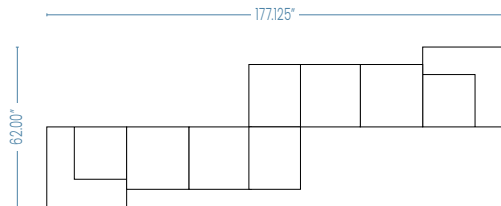

Back to Back Configuration

- (4) CW3131 M03P
- (4) CW2431 M03P

Total List: \$23,052

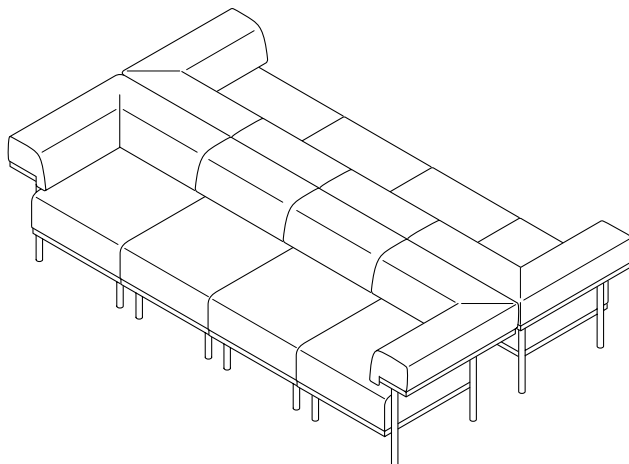
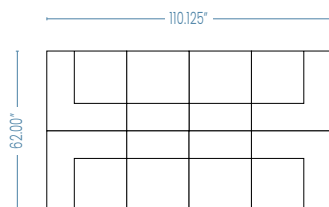

Angled Configuration

- (1) CW2430 L01LP
- (2) CW2424
- (1) CW30D18WG
- (1) CW2431 M03P
- (1) CW3131 M03P

Total List: \$12,664

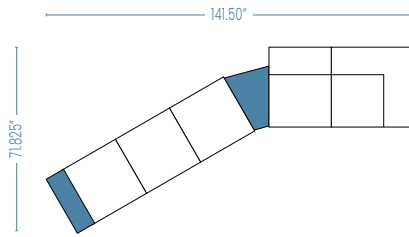
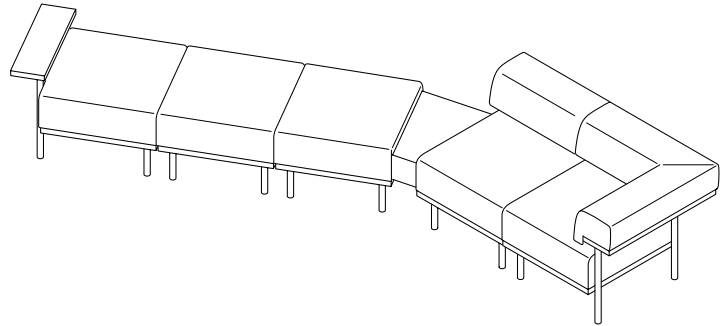

Pinwheel Configuration

- (1) CW2466 L03P
- (4) CW2424
- (1) CW3131 L03P
- (1) CW3030 L01LP
- (1) CW3131 H03P
- (1) CW3131 M03P

Total List: \$23,076

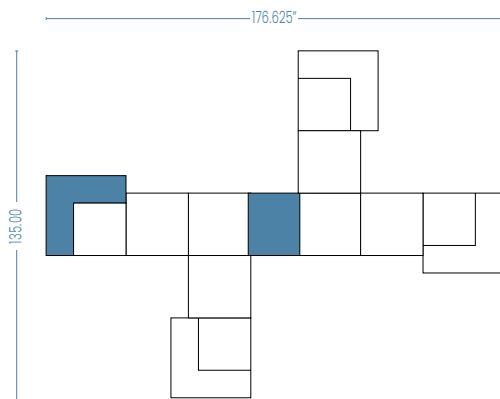
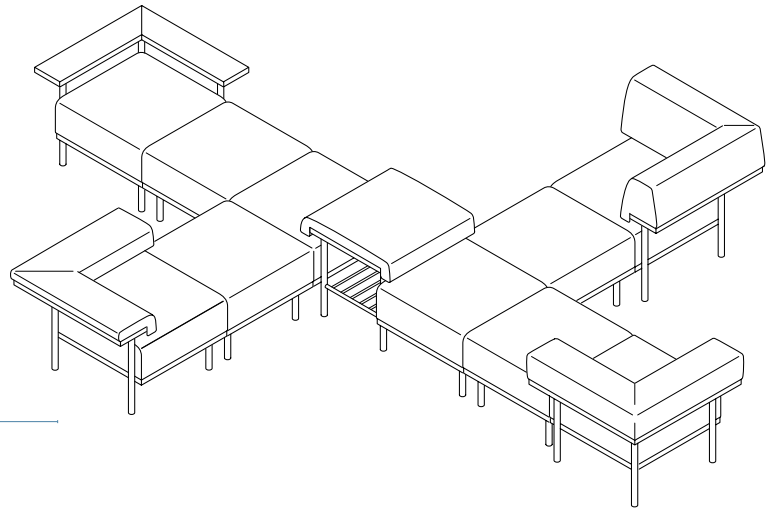

To Order, Specify...

- 1 Model Number, include edge style
- 2 Leg + Frame Color
- 3 Seat Upholstery Selection
- 4 Bumper Upholstery Selection
- 5 Ledge Material
 - a. Laminate manufacturer + color
 - b. Veneer species + finish color
 - c. Upholstery Selection
- 6 Ledge Edge Color or Finish
- 7 Additional Options

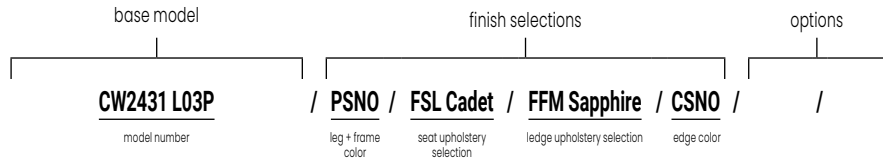

A **CW2431 L03P** is a Catwalk series, single with upholstered seat and upholstered low padded ledge and flat PVC edge.

The codes **PSNO / FSL Cadet / FFM Sapphire / CSNO** specify Snow legs and frame color with Grade 3 Solitaire Cadet upholstery for the seat and a Grade 4 Faux Mo Sapphire fabric for the ledge with a Snow PVC edge.

Model Number CW2431 L03P

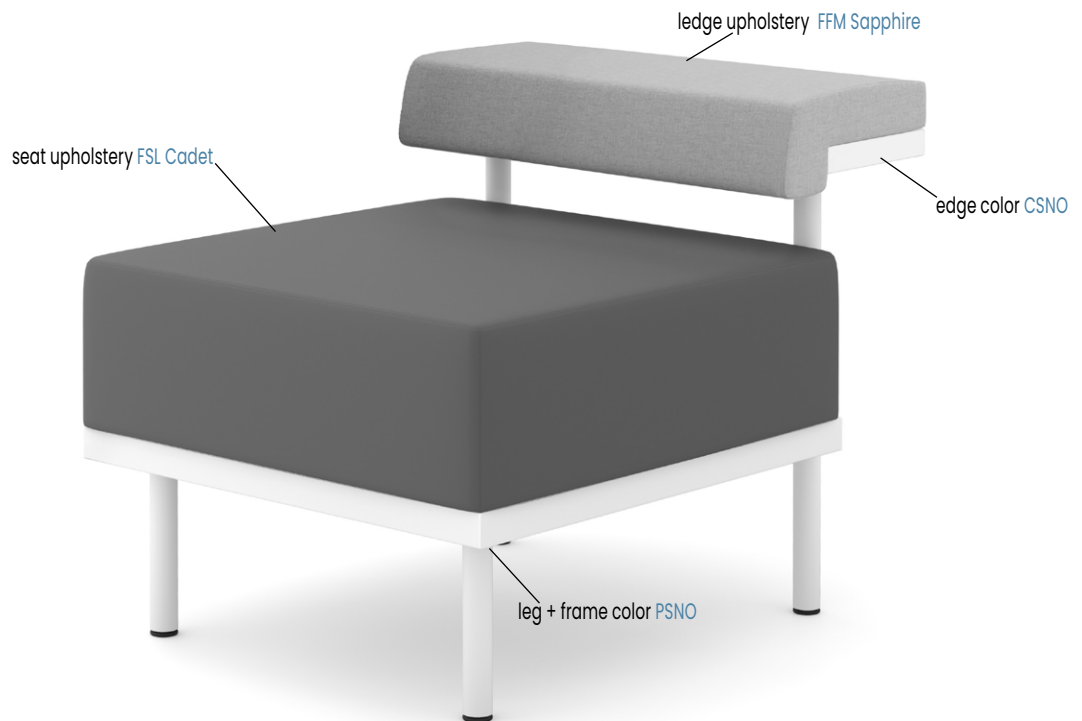

Orders may be sent via

Mailing Address
Versteel
2332 Cathy Lane
Jasper IN 47546

Contact Versteel

Email contact@versteel.com
Phone 800 876 2120
 812 634 2120
Fax 812 482 9318

Powder Coat Finishes

All powder coat finishes in the Versteel offering have been formulated with the use of epoxy, polyester or epoxy and polyester blends to maximize the finish durability.

Powder Coat Finish Options

Powder Coat – Standard	n/c
Powder Coat – Premium.	\$165

Powder Coat Colors

AlloyPALY	NavyPNAV
AmethystPAME	Nimbus.PNIM
AnthracitePANT	NutmegPNUT
Black Anodized.PBLA	PearlPPEA
BronzePBRO	PebblePPEB
CalypsoPCAL	PlatinumPPLA
CarbonPCAR	Poppy.PPOP
ChampagnePCHA	RoyalPROY
CoconutPCOC	SeasidePSEA
CrimsonPCRI	ShipyardPSHI
Daffodil.PDAF	SilverPSIL
EbonyPEBO	SnowPSNO
Forest.PFOR	StonePSTO
FossilPFOS	Storm.PSTM
GraphitePGRA	Terra CottaPTEC
HopePHOP	WhisperPWHI
Kelly GreenPKEG	White LinenPWHL
Mica.PMIC	Powder Coat Alternative .	.OPA
MintPMNT		

NOTE TRANSPARENT POWDER COATS ARE NOT AVAILABLE ON CATWALK

Premium Powder Coats (indicated by Ⓢ)

Versteel’s premium process uses specially formulated powder coats for a truly unique color palette.

Plated

Versteel offers two plated options: Chrome and Nickel. Chrome is our most durable finish available and is a deep luster chrome plated finish. Nickel is a plated finish with a clear coat applied for durability. An upcharge applies for plated finishes. See product pricing pages for upcharge.

Chrome	ECHR
Nickel	ENKL

Laminate

Versteel’s standard offering of laminates includes over 900 laminates from Formica, Nevamar, Pionite and Wilsonart.

Laminate manufacturers change standard offerings frequently, making it possible a standard product can become unavailable. Versteel cannot be responsible for any inconvenience this may cause.

PVC Edge Colors

Absolute AcajouCABA	Nimbus.CNIM
Alloy.CALY	PearlCPEA
Carbon.CCAR	PlatinumCPLA
ChampagneCCHA	Pralines & CreamCPRC
CoconutCCOC	ShadowCSHA
Ebony.CEBO	SnowCSNO
Florence WalnutCFLW	StoneCSTO
FossilCFOS	StormCSTM
GrahitteCGRA	WhisperCWHI
Grey.CGRE	White LinenCWHL
Kensington Maple.CKEM		

Wood Edge Species

AshA01	Maple.M01
CherryC01	WalnutW01

Wood Edge Finishes

Ash			
Beach.WBEA	FogWFOG
Chestnut.WCHE	PebbleWPEB
DriftWDRI	WhisperWWHI
FawnWFAW		

Cherry

Blossom CherryWBLC	Java Cherry.WJAC
Cordovan CherryWCNC	Millwork Cherry.WMWC
Golden CherryWGNC		

Maple

Caramel MapleWCMM	Sugar MapleWSUM
Solar Maple.WSLM		

Walnut

Brighton WalnutWBRW	Natural Walnut.WNAW
Espresso Walnut.WESW		

Veneer

Catwalk ledges are available with plain sliced Ash, Cherry, Maple and Walnut veneers.

Veneer Species

Ash	AP01	Maple.	MP01
Cherry	CP01	Walnut	WP01

Veneer Finish**Ash**

Beach.	VBEA	Fog	VFOG
Chestnut.	VCHE	Pebble	VPEB
Drift	VDRI	Whisper	VWHI
Fawn	VFAW		

Cherry

Blossom Cherry	VBLC	Java Cherry.	VJAC
Cordovan Cherry	VCNC	Millwork Cherry.	VMWC
Golden Cherry	VGNC		

Maple

Caramel Maple	VCMM	Sugar Maple	VSUM
Solar Maple.	VSLM		

Walnut

Brighton Walnut	VBRW	Natural Walnut.	VNAW
Espresso Walnut.	VESW		

Finish Reference & Samples

For finish color reference, please refer to our website. Contact Versteel Customer Service to receive actual color samples for color matches and final color approval.

Powder Coat Alternative**Call for quotation**

Specify code **OPA** (Powder Coat Alternative), add cost from Versteel quotation

Powder Coat Alternative is available from Versteel. The entire RAL color reference along with hundreds of other color and finishes are available.

For Powder Coat Alternative matching, you must supply a color reference sample, or an RAL number. Versteel will review the sample for possible existing colors available and send a sample for customer approval. If no color match exists a custom match can be developed. Call Versteel Customer Service for associated upcharges on custom color development.

NOTE CUSTOM COLOR MATCHING APPROVALS MAY AFFECT STANDARD PRODUCTION SCHEDULES

Special Laminate**Call for quotation**

Specify code **TSP** (Special Laminate), indicate the quoted charges per table

Special laminates and patterns can be specified as an option on Troupe. To specify, contact Versteel for availability and pricing.

NOTE LAMINATES IN STANDARD COLORS AND TEXTURES FROM FORMICA, NEVAMAR, PIONITE AND WILSONART ARE STANDARD

CAUTION LAMINATE MANUFACTURERS CHANGE STANDARD OFFERINGS FREQUENTLY, AND IT IS POSSIBLE THAT A STANDARD PRODUCT CAN BECOME UNAVAILABLE. VERSTEEL CANNOT BE RESPONSIBLE FOR ANY INCONVENIENCE THIS MAY CAUSE.

Custom PVC Color Match**Call for quotation / one time charge per color, per order**

Specify code **OCF** (Custom PVC Color Match), add cost from Versteel quotation

PVC Color Match can be the selection of a color that is available from a Versteel supplier or a new custom color developed for the order. Minimum footage requirements mean that the amount of material needed for your order will effect the cost.

For PVC Color Matching you must supply a color reference sample. Versteel will review the sample for possible existing colors available and send a sample for customer approval. If no color match exists, a custom match will be developed and sampled for customer approval before a production schedule is established.

NOTE CUSTOM COLOR MATCHING APPROVALS MAY AFFECT STANDARD PRODUCTION SCHEDULES

Stain Finish Match**\$957 / one time charge per finish, per order**

Specify code **OSM** (Stain Finish Match), add \$957.00 list per finish, per order

Alternative Stain Finishes are available for veneer and wood edged tops.

For Stain Finish Matching you must supply two 4" x 4" finish color and grain reference samples. An expertly finish matched sample will be provided for customer approval.

NOTE CUSTOM COLOR MATCHING APPROVALS MAY AFFECT STANDARD PRODUCTION SCHEDULES

Veneer or Wood Edge Alternatives

For veneer or wood edge requirements other than our standard plain sliced Ash, Cherry, Maple or Walnut, contact Versteel Customer Service with the specifications of the materials you would like to specify.

NOTE VENEER OR WOOD EDGE ALTERNATIVES APPROVAL MAY AFFECT STANDARD PRODUCTION SCHEDULES

Wood Finish Alternatives

Versteel finish has a natural grain fill level finish appearance, contact Versteel Customer Service for alternative fill levels. Coarse grain will require additional application steps for a full-fill grain appearance and will require a quote.

NOTE WOOD FINISH ALTERNATIVE APPROVAL MAY AFFECT STANDARD PRODUCTION SCHEDULES

Salt or Pepper

Individual dual USB charger or power outlet for easy, quick access applications.

SPECIFICATIONS

- Salt or Pepper hole mount is 1 3/4" diameter
- Spill-proof power simplex
- Square grommet
- 72" long power cord

Model	Description	
SSLT3	One (1) single port high power USB C charger	\$435 list
SSLT4	One (1) USB A + USB C Charger	\$262 list
SPPR	One (1) power outlet	\$115 list

Unit Color

BERP	Berry	n/c
BLKP	Black	n/c
DSKP	Dusk	n/c
FOGP	Fog	n/c
HNYP	Honey	n/c
NVYP	Navy	n/c
PCKP	Peacock	n/c
PPYP	Poppy	n/c
SRMP	Storm	n/c
WHTP	White	n/c

Model Example: SSLT4-BLKP

Single

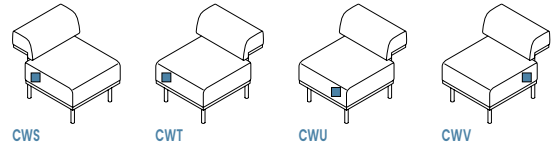

Corner

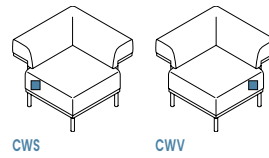

End (electrical on same side as low padded ledge only)

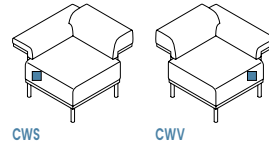

Split Level

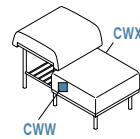



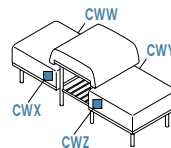

Bridge

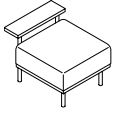
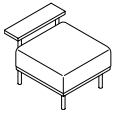
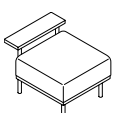

Questions?



1.800.876.2120

Model #	Description	Dimensions	Product Wt	material >	Fabric	Fabric	Fabric	Fabric	Fabric
				grade >	Grade 2 or COM	Grade 3	Grade 4	Grade 5	Grade 6
 CW2430 L01LP	Single with Ledge Seat - Upholstered Ledge - Laminate/Flat PVC	Overall Height: 22" Overall Width: 30 ¹ / ₄ " Overall Depth: 24" Seat Height: 17 ¹ / ₂ " Seat Width: 23" Seat Depth: 24" Ledge Depth: 7 ¹ / ₄ "	44	1992	2132	2412	2833	3394	
 CW2430 L01LW	Single with Ledge Seat - Upholstered Ledge - Laminate/Flat Wood	Overall Height: 22" Overall Width: 30 ¹ / ₄ " Overall Depth: 24" Seat Height: 17 ¹ / ₂ " Seat Width: 23" Seat Depth: 24" Ledge Depth: 7 ¹ / ₄ "	44	2170	2310	2590	3011	3572	
 CW2430 L01VW	Single with Ledge Seat - Upholstered Ledge - Veneer/Flat Wood	Overall Height: 22" Overall Width: 30 ¹ / ₄ " Overall Depth: 24" Seat Height: 17 ¹ / ₂ " Seat Width: 23" Seat Depth: 24" Ledge Depth: 7 ¹ / ₄ "	44	2527	2667	2948	3368	3930	
 CW2430 L02LP	Single with Low Bumper Ledge Seat - Upholstered Bumper - Upholstered Ledge - Laminate/Flat PVC	Overall Height: 24 ¹ / ₄ " Overall Width: 30 ¹ / ₄ " Overall Depth: 24" Seat Height: 17 ¹ / ₂ " Seat Width: 20 ³ / ₈ " Seat Depth: 24" Ledge Depth: 6 ¹ / ₄ "	46	2324	2534	2954	3585	4427	
 CW2430 L02LW	Single with Low Bumper Ledge Seat - Upholstered Bumper - Upholstered Ledge - Laminate/Flat Wood	Overall Height: 24 ¹ / ₄ " Overall Width: 30 ¹ / ₄ " Overall Depth: 24" Seat Height: 17 ¹ / ₂ " Seat Width: 20 ³ / ₈ " Seat Depth: 24" Ledge Depth: 6 ¹ / ₄ "	46	2502	2712	3132	3763	4605	
 CW2430 L02VW	Single with Low Bumper Ledge Seat - Upholstered Bumper - Upholstered Ledge - Veneer/Flat Wood	Overall Height: 24 ¹ / ₄ " Overall Width: 30 ¹ / ₄ " Overall Depth: 24" Seat Height: 17 ¹ / ₂ " Seat Width: 20 ³ / ₈ " Seat Depth: 24" Ledge Depth: 6 ¹ / ₄ "	46	2857	3067	3489	4120	4960	

To Order, Specify...

- 1 Model Number
- 2 Leg + Frame Color
- 3 Seat Upholstery Selection
- 4 Bumper Upholstery Selection
- 5 Ledge Material
 - a. Laminate Manufacturer + Color
 - b. Veneer Species + Finish Color
 - c. Upholstery Selection
- 6 Ledge Edge Color or Finish
- 7 Additional Options

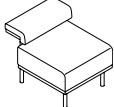
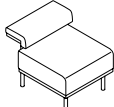
Questions?
1.800.876.2120

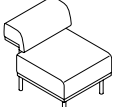
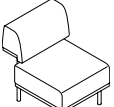
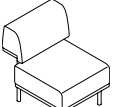
				material > grade >	Fabric Grade 2 or COM	Fabric Grade 3	Fabric Grade 4	Fabric Grade 5	Fabric Grade 6
Model #	Description	Dimensions	Product Wt						
 CW2431 L03P	Single with Low Padded Ledge Seat - Upholstered Ledge - Upholstered/ Flat PVC	Overall Height: 24 ³ / ₈ " Overall Width: 30 ⁷ / ₈ " Overall Depth: 24" Seat Height: 17 ¹ / ₂ " Seat Width: 20 ³ / ₈ " Seat Depth: 24" Ledge Depth: 10 ¹ / ₂ "	48	2371	2581	3001	3632	4474	
 CW2431 L03W	Single with Low Padded Ledge Seat - Upholstered Ledge - Upholstered/ Flat Wood	Overall Height: 24 ³ / ₈ " Overall Width: 30 ⁷ / ₈ " Overall Depth: 24" Seat Height: 17 ¹ / ₂ " Seat Width: 20 ³ / ₈ " Seat Depth: 24" Ledge Depth: 10 ¹ / ₂ "	48	2548	2759	3179	3810	4651	
 CW2431 M03P	Single with Mid Padded Ledge Seat - Upholstered Ledge - Upholstered/ Flat PVC	Overall Height: 28" Overall Width: 30 ⁷ / ₈ " Overall Depth: 24" Seat Height: 17 ¹ / ₂ " Seat Width: 20 ³ / ₈ " Seat Depth: 24" Ledge Depth: 10 ¹ / ₂ "	53	2559	2840	3400	4242	5364	
 CW2431 M03W	Single with Mid Padded Ledge Seat - Upholstered Ledge - Upholstered/ Flat Wood	Overall Height: 28" Overall Width: 30 ⁷ / ₈ " Overall Depth: 24" Seat Height: 17 ¹ / ₂ " Seat Width: 20 ³ / ₈ " Seat Depth: 24" Ledge Depth: 10 ¹ / ₂ "	53	2738	3018	3579	4419	5542	
 CW2431 H03P	Single with High Padded Ledge Seat - Upholstered Ledge - Upholstered/Flat PVC	Overall Height: 32" Overall Width: 30 ³ / ₄ " Overall Depth: 24" Seat Height: 17 ¹ / ₂ " Seat Width: 20 ³ / ₈ " Seat Depth: 24" Ledge Depth: 10 ³ / ₈ "	55	2596	2876	3438	4279	5400	
 CW2431 H03W	Single with High Padded Ledge Seat - Upholstered Ledge - Upholstered/Flat Wood	Overall Height: 32" Overall Width: 30 ³ / ₄ " Overall Depth: 24" Seat Height: 17 ¹ / ₂ " Seat Width: 20 ³ / ₈ " Seat Depth: 24" Ledge Depth: 10 ³ / ₈ "	55	2774	3055	3616	4457	5578	

Leg + Frame Finish	Price
Chrome	\$ 165
Nickel	\$ 223
Powder Coat - Standard	n/c
Powder Coat - Premium	\$ 165



Power + Charging Options
See page 20 for power and charging options.

Custom Charges	Code	Price
Powder Coat Alternative (per color)	OPA	call

TRANSPARENT POWDER COAT NOT AVAILABLE

Questions?

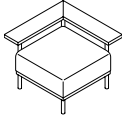
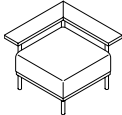
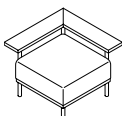
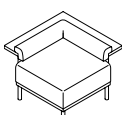
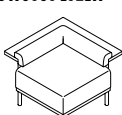
1.800.876.2120

Model #	Description	Dimensions	Product Wt	material > grade >					
				Fabric Grade 2 or COM	Fabric Grade 3	Fabric Grade 4	Fabric Grade 5	Fabric Grade 6	
 CW3030 L01LP	Corner with Ledge Seat - Upholstered Ledge - Laminate/Flat PVC	Overall Height: 22" Overall Width: 30 ¹ / ₄ " Overall Depth: 30 ¹ / ₄ " Seat Height: 17 ¹ / ₂ " Seat Width: 23" Seat Depth: 23" Ledge Depth: 7 ¹ / ₄ "	53	2183	2324	2604	3025	3585	
 CW3030 L01LW	Corner with Ledge Seat - Upholstered Ledge - Laminate/Flat Wood	Overall Height: 22" Overall Width: 30 ¹ / ₄ " Overall Depth: 30 ¹ / ₄ " Seat Height: 17 ¹ / ₂ " Seat Width: 23" Seat Depth: 23" Ledge Depth: 7 ¹ / ₄ "	53	2540	2681	2961	3382	3942	
 CW3030 L01VW	Corner with Ledge Seat - Upholstered Ledge - Veneer/Flat Wood	Overall Height: 22" Overall Width: 30 ¹ / ₄ " Overall Depth: 30 ¹ / ₄ " Seat Height: 17 ¹ / ₂ " Seat Width: 23" Seat Depth: 23" Ledge Depth: 7 ¹ / ₄ "	53	3254	3394	3675	4095	4656	
 CW3030 L02LP	Corner with Low Bumper Ledge Seat - Upholstered Bumper - Upholstered Ledge - Laminate/Flat PVC	Overall Height: 24 ¹ / ₄ " Overall Width: 30 ¹ / ₄ " Overall Depth: 30 ¹ / ₄ " Seat Height: 17 ¹ / ₂ " Seat Width: 20 ³ / ₈ " Seat Depth: 20 ³ / ₈ " Ledge Depth: 6 ¹ / ₄ "	56	2729	3010	3571	4412	5534	
 CW3030 L02LW	Corner with Low Bumper Ledge Seat - Upholstered Bumper - Upholstered Ledge - Laminate/Flat Wood	Overall Height: 24 ¹ / ₄ " Overall Width: 30 ¹ / ₄ " Overall Depth: 30 ¹ / ₄ " Seat Height: 17 ¹ / ₂ " Seat Width: 20 ³ / ₈ " Seat Depth: 20 ³ / ₈ " Ledge Depth: 6 ¹ / ₄ "	56	3086	3366	3926	4768	5890	
 CW3030 L02VW	Corner with Low Bumper Ledge Seat - Upholstered Bumper - Upholstered Ledge - Veneer/Flat Wood	Overall Height: 24 ¹ / ₄ " Overall Width: 30 ¹ / ₄ " Overall Depth: 30 ¹ / ₄ " Seat Height: 17 ¹ / ₂ " Seat Width: 20 ³ / ₈ " Seat Depth: 20 ³ / ₈ " Ledge Depth: 6 ¹ / ₄ "	56	3799	4079	4640	5481	6603	

To Order, Specify...

- 1 Model Number
- 2 Leg + Frame Color
- 3 Seat Upholstery Selection
- 4 Bumper Upholstery Selection
- 5 Ledge Material
 - a. Laminate Manufacturer + Color
 - b. Veneer Species + Finish Color
 - c. Upholstery Selection
- 6 Ledge Edge Color or Finish
- 7 Additional Options

Questions?
1.800.876.2120

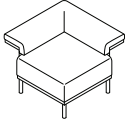
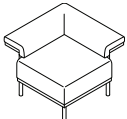
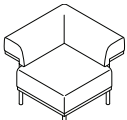
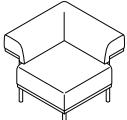
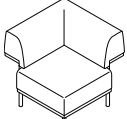
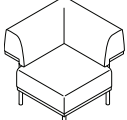
Model #	Description	Dimensions	Product Wt	material > grade >	Fabric Grade 2 or COM	Fabric Grade 3	Fabric Grade 4	Fabric Grade 5	Fabric Grade 6
 CW3131 L03P	Corner with Low Padded Ledge Seat - Upholstered Ledge - Upholstered/ Flat PVC	Overall Height: 24 ³ / ₈ " Overall Width: 30 ⁷ / ₈ " Overall Depth: 30 ⁷ / ₈ " Seat Height: 17 ¹ / ₂ " Seat Width: 20 ³ / ₈ " Seat Depth: 20 ³ / ₈ " Ledge Depth: 10 ¹ / ₂ "	62		2850	3130	3691	4533	5654
 CW3131 L03W	Corner with Low Padded Ledge Seat - Upholstered Ledge - Upholstered/ Flat Wood	Overall Height: 24 ³ / ₈ " Overall Width: 30 ⁷ / ₈ " Overall Depth: 30 ⁷ / ₈ " Seat Height: 17 ¹ / ₂ " Seat Width: 20 ³ / ₈ " Seat Depth: 20 ³ / ₈ " Ledge Depth: 10 ¹ / ₂ "	62		3207	3488	4048	4890	6012
 CW3131 M03P	Corner with Mid Padded Ledge Seat - Upholstered Ledge - Upholstered/ Flat PVC	Overall Height: 28" Overall Width: 30 ⁷ / ₈ " Overall Depth: 30 ⁷ / ₈ " Seat Height: 17 ¹ / ₂ " Seat Width: 20 ³ / ₈ " Seat Depth: 20 ³ / ₈ " Ledge Depth: 10 ¹ / ₂ "	72		3204	3554	4255	5307	6708
 CW3131 M03W	Corner with Mid Padded Ledge Seat - Upholstered Ledge - Upholstered/ Flat Wood	Overall Height: 28" Overall Width: 30 ⁷ / ₈ " Overall Depth: 30 ⁷ / ₈ " Seat Height: 17 ¹ / ₂ " Seat Width: 20 ³ / ₈ " Seat Depth: 20 ³ / ₈ " Ledge Depth: 10 ¹ / ₂ "	72		3559	3910	4612	5663	7065
 CW3131 H03P	Corner with High Padded Ledge Seat - Upholstered Ledge - Upholstered/ Flat PVC	Overall Height: 32" Overall Width: 30 ³ / ₄ " Overall Depth: 30 ³ / ₄ " Seat Height: 17 ¹ / ₂ " Seat Width: 20 ³ / ₈ " Seat Depth: 20 ³ / ₈ " Ledge Depth: 10 ³ / ₈ "	80		3344	3764	4606	5868	7550
 CW3131 H03W	Corner with High Padded Ledge Seat - Upholstered Ledge - Upholstered/ Flat Wood	Overall Height: 32" Overall Width: 30 ³ / ₄ " Overall Depth: 30 ³ / ₄ " Seat Height: 17 ¹ / ₂ " Seat Width: 20 ³ / ₈ " Seat Depth: 20 ³ / ₈ " Ledge Depth: 10 ³ / ₈ "	80		3700	4121	4962	6224	7907

Leg + Frame Finish	Price
Chrome	\$ 165
Nickel	\$ 223
Powder Coat - Standard	n/c
Powder Coat - Premium	\$ 165

TRANSPARENT POWDER COAT NOT AVAILABLE

Power+ Charging Options
See page 20 for power and charging options.

Custom Charges
Powder Coat Alternative (per color) OPA **Code** **Price**
call

Questions?

1.800.876.2120

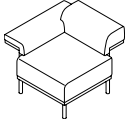
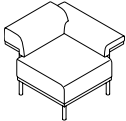
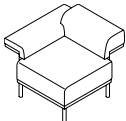
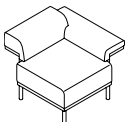
Model #	Description	Dimensions	Product Wt	material >	Fabric	Fabric	Fabric	Fabric	Fabric
				grade >	Grade 2 or COM	Grade 3	Grade 4	Grade 5	Grade 6
	CW3131 LRMB03P End with Low Padded Ledge - Right, Mid Padded Ledge - Back Seat - Upholstered Ledge - Upholstered/ Flat PVC	Overall Height: 28" Overall Width: 30 ⁷ / ₈ " Overall Depth: 30 ⁷ / ₈ " Seat Height: 17 ¹ / ₂ " Seat Width: 20 ³ / ₈ " Seat Depth: 20 ³ / ₈ " Low Ledge Depth: 10 ¹ / ₂ " Mid Ledge Depth: 10 ¹ / ₂ "	66	3155	3505	4206	5258	6660	
	CW3131 LLMB03P End with Low Padded Ledge - Left, Mid Padded Ledge - Back Seat - Upholstered Ledge - Upholstered/ Flat PVC	Overall Height: 28" Overall Width: 30 ⁷ / ₈ " Overall Depth: 30 ⁷ / ₈ " Seat Height: 17 ¹ / ₂ " Seat Width: 20 ³ / ₈ " Seat Depth: 20 ³ / ₈ " Low Ledge Depth: 10 ¹ / ₂ " Mid Ledge Depth: 10 ¹ / ₂ "	66	3155	3505	4206	5258	6660	
	CW3131 LRMB03W End with Low Padded Ledge - Right, Mid Padded Ledge - Back Seat - Upholstered Ledge - Upholstered/ Flat Wood	Overall Height: 28" Overall Width: 30 ⁷ / ₈ " Overall Depth: 30 ⁷ / ₈ " Seat Height: 17 ¹ / ₂ " Seat Width: 20 ³ / ₈ " Seat Depth: 20 ³ / ₈ " Low Ledge Depth: 10 ¹ / ₂ " Mid Ledge Depth: 10 ¹ / ₂ "	66	3510	3861	4562	5614	7016	
	CW3131 LLMB03W End with Low Padded Ledge - Left, Mid Padded Ledge - Back Seat - Upholstered Ledge - Upholstered/ Flat Wood	Overall Height: 28" Overall Width: 30 ⁷ / ₈ " Overall Depth: 30 ⁷ / ₈ " Seat Height: 17 ¹ / ₂ " Seat Width: 20 ³ / ₈ " Seat Depth: 20 ³ / ₈ " Low Ledge Depth: 10 ¹ / ₂ " Mid Ledge Depth: 10 ¹ / ₂ "	66	3510	3861	4562	5614	7016	

To Order, Specify...

- 1 Model Number
- 2 Leg + Frame Color
- 3 Seat Upholstery Selection
- 4 Ledge Upholstery Selection
- 5 Ledge Edge Color or Finish
- 6 Additional Options

Questions?
1.800.876.2120

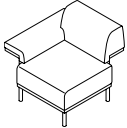
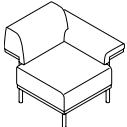
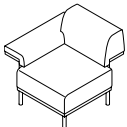
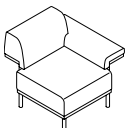
Model #	Description	Dimensions	Product Wt	material > grade >	Fabric Grade 2 or COM	Fabric Grade 3	Fabric Grade 4	Fabric Grade 5	Fabric Grade 6
 CW3131 LRHB03P	End with Low Padded Ledge - Right, High Padded Ledge - Back Seat - Upholstered Ledge - Upholstered/ Flat PVC	Overall Height: 32" Overall Width: 30 ⁷ / ₈ " Overall Depth: 30 ³ / ₄ " Seat Height: 17 ¹ / ₂ " Seat Width: 20 ³ / ₈ " Seat Depth: 20 ³ / ₈ " Low Ledge Depth: 10 ¹ / ₂ " High Ledge Depth: 10 ³ / ₈ "	69		3155	3505	4206	5258	6660
 CW3131 LLHB03P	End with Low Padded Ledge - Left, High Padded Ledge - Back Seat - Upholstered Ledge - Upholstered/ Flat PVC	Overall Height: 32" Overall Width: 30 ⁷ / ₈ " Overall Depth: 30 ³ / ₄ " Seat Height: 17 ¹ / ₂ " Seat Width: 20 ³ / ₈ " Seat Depth: 20 ³ / ₈ " Low Ledge Depth: 10 ¹ / ₂ " High Ledge Depth: 10 ³ / ₈ "	69		3155	3505	4206	5258	6660
 CW3131 LRHB03W	End with Low Padded Ledge - Right, High Padded Ledge - Back Seat - Upholstered Ledge - Upholstered/ Flat Wood	Overall Height: 32" Overall Width: 30 ⁷ / ₈ " Overall Depth: 30 ³ / ₄ " Seat Height: 17 ¹ / ₂ " Seat Width: 20 ³ / ₈ " Seat Depth: 20 ³ / ₈ " Low Ledge Depth: 10 ¹ / ₂ " High Ledge Depth: 10 ³ / ₈ "	69		3510	3861	4562	5614	7016
 CW3131 LLHB03W	End with Low Padded Ledge - Left, High Padded Ledge - Back Seat - Upholstered Ledge - Upholstered/ Flat Wood	Overall Height: 32" Overall Width: 30 ⁷ / ₈ " Overall Depth: 30 ³ / ₄ " Seat Height: 17 ¹ / ₂ " Seat Width: 20 ³ / ₈ " Seat Depth: 20 ³ / ₈ " Low Ledge Depth: 10 ¹ / ₂ " High Ledge Depth: 10 ³ / ₈ "	69		3510	3861	4562	5614	7016

Leg + Frame Finish	Price
Chrome	\$ 165
Nickel	\$ 223
Powder Coat - Standard	n/c
Powder Coat - Premium	\$ 165

TRANSPARENT POWDER COAT NOT AVAILABLE

Power + Charging Options
See page 20 for power and charging options.

Custom Charges	Code	Price
Powder Coat Alternative (per color)	OPA	call

Questions?

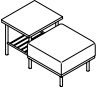
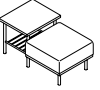
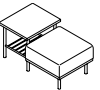

1.800.876.2120

				material > grade >	Fabric Grade 2 or COM	Fabric Grade 3	Fabric Grade 4	Fabric Grade 5	Fabric Grade 6
Model #	Description	Dimensions	Product Wt						
 CW2443 L01LP	Single with Top Seat - Upholstered Top - Laminate/Flat PVC	Overall Height: 22" Overall Width: 43" Overall Depth: 24" Seat Height: 17 1/2" Seat Width: 23" Seat Depth: 24" Top Size: 20" x 24"	65	2634	2774	3055	3475	4036	
 CW2443 L01LW	Single with Top Seat - Upholstered Top - Laminate/Flat Wood	Overall Height: 22" Overall Width: 43" Overall Depth: 24" Seat Height: 17 1/2" Seat Width: 23" Seat Depth: 24" Top Size: 20" x 24"	65	2890	3030	3311	3731	4292	
 CW2443 L01VW	Single with Top Seat - Upholstered Top - Veneer/Flat Wood	Overall Height: 22" Overall Width: 43" Overall Depth: 24" Seat Height: 17 1/2" Seat Width: 23" Seat Depth: 24" Top Size: 20" x 24"	65	3400	3541	3821	4242	4803	

To Order, Specify...

- 1 Model Number
- 2 Leg + Frame Color
- 3 Seat Upholstery Selection
- 4 Ledge Material
 - a. Laminate manufacturer + color
 - b. Veneer species + finish color
 - c. Upholstery Selection
- 5 Ledge Edge Color or Finish
- 7 Additional Options

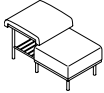
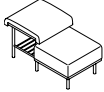
Questions?
1.800.876.2120

Model #	Description	Dimensions	Product Wt	material > grade >	Fabric Grade 2 or COM	Fabric Grade 3	Fabric Grade 4	Fabric Grade 5	Fabric Grade 6
 CW2446 L03P	Single with Low Padded Top Seat - Upholstered Top - Upholstered/Flat PVC	Overall Height: 24 ⁷ / ₈ " Overall Width: 45 ⁵ / ₈ " Overall Depth: 24" Seat Height: 17 ¹ / ₂ " Seat Width: 20 ³ / ₈ " Seat Depth: 24" Top Size: 25 ¹ / ₄ " x 24"	77		3111	3392	3952	4794	5916
 CW2446 L03W	Single with Low Padded Top Seat - Upholstered Top - Upholstered/Flat Wood	Overall Height: 24 ⁷ / ₈ " Overall Width: 45 ⁵ / ₈ " Overall Depth: 24" Seat Height: 17 ¹ / ₂ " Seat Width: 20 ³ / ₈ " Seat Depth: 24" Top Size: 25 ¹ / ₄ " x 24"	77		3366	3647	4207	5049	6171
 CW2446 M03P	Single with Mid Padded Top Seat - Upholstered Top - Upholstered/Flat PVC	Overall Height: 28 ¹ / ₂ " Overall Width: 45 ⁵ / ₈ " Overall Depth: 24" Seat Height: 17 ¹ / ₂ " Seat Width: 20 ³ / ₈ " Seat Depth: 24" Top Size: 25 ¹ / ₄ " x 24"	91		3295	3575	4137	4978	6099
 CW2446 M03W	Single with Mid Padded Top Seat - Upholstered Top - Upholstered/Flat Wood	Overall Height: 28 ¹ / ₂ " Overall Width: 45 ⁵ / ₈ " Overall Depth: 24" Seat Height: 17 ¹ / ₂ " Seat Width: 20 ³ / ₈ " Seat Depth: 24" Top Size: 25 ¹ / ₄ " x 24"	91		3551	3831	4392	5234	6355

Leg + Frame Finish	Price
Chrome	\$ 165
Nickel	\$ 223
Powder Coat - Standard	n/c
Powder Coat - Premium	\$ 165

TRANSPARENT POWDER COAT NOT AVAILABLE

Power + Charging Options
See page 20 for power and charging options.

Custom Charges	Code	Price
Powder Coat Alternative (per color)	OPA	call

Questions?

1.800.876.2120

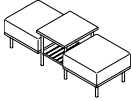
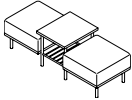
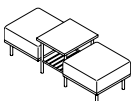
				material > grade >	Fabric Grade 2 or COM	Fabric Grade 3	Fabric Grade 4	Fabric Grade 5	Fabric Grade 6
Model #	Description	Dimensions	Product Wt						
 CW2466 L01LP	Two Singles with Top Seats - Upholstered Top - Laminate/Flat PVC	Overall Height: 22" Overall Width: 66" Overall Depth: 24" Seat Height: 17½" Seat Width: 23" Seat Depth: 24" Top Size: 20" x 24"	93	4175	4385	4806	5437	6278	
 CW2466 L01LW	Two Singles with Top Seats - Upholstered Top - Laminate/Flat Wood	Overall Height: 22" Overall Width: 66" Overall Depth: 24" Seat Height: 17½" Seat Width: 23" Seat Depth: 24" Top Size: 20" x 24"	93	4430	4640	5061	5691	6533	
 CW2466 L01VW	Two Singles with Top Seats - Upholstered Top - Veneer/Flat Wood	Overall Height: 22" Overall Width: 66" Overall Depth: 24" Seat Height: 17½" Seat Width: 23" Seat Depth: 24" Top Size: 20" x 24"	93	4942	5153	5573	6204	7045	

To Order, Specify...

- 1 Model Number
- 2 Leg + Frame Color
- 3 Seat Upholstery
- 4 Top Material
 - a. Laminate manufacturer + color
 - b. Veneer species + finish color
 - c. Upholstery Selection
- 6 Ledge Edge Color or Finish
- 7 Additional Options

Questions?
1.800.876.2120

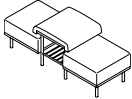
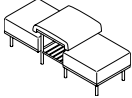
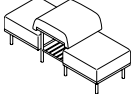
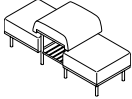
Model #	Description	Dimensions	Product Wt	material > grade >	Fabric Grade 2 or COM	Fabric Grade 3	Fabric Grade 4	Fabric Grade 5	Fabric Grade 6
 CW2466 L03P	Two Singles with Low Padded Top Seats - Upholstered Top - Upholstered/Flat PVC	Overall Height: 24 ⁷ / ₈ " Overall Width: 66" Overall Depth: 24" Seat Height: 17 ¹ / ₂ " Seat Width: 20 ³ / ₈ " Seat Depth: 24" Top Size: 25 ¹ / ₄ " x 24"	105		4651	5002	5703	6754	8157
 CW2466 L03W	Two Singles with Low Padded Top Seats - Upholstered Top - Upholstered/Flat Wood	Overall Height: 24 ⁷ / ₈ " Overall Width: 66" Overall Depth: 24" Seat Height: 17 ¹ / ₂ " Seat Width: 20 ³ / ₈ " Seat Depth: 24" Top Size: 25 ¹ / ₄ " x 24"	105		4907	5258	5959	7010	8413
 CW2466 M03P	Two Singles with Mid Padded Top Seats - Upholstered Top - Upholstered/Flat PVC	Overall Height: 28 ¹ / ₂ " Overall Width: 66" Overall Depth: 24" Seat Height: 17 ¹ / ₂ " Seat Width: 20 ³ / ₈ " Seat Depth: 24" Top Size: 25 ¹ / ₄ " x 24"	120		4836	5187	5888	6939	8341
 CW2466 M03W	Two Singles with Mid Padded Top Seats - Upholstered Top - Upholstered/Flat Wood	Overall Height: 28 ¹ / ₂ " Overall Width: 66" Overall Depth: 24" Seat Height: 17 ¹ / ₂ " Seat Width: 20 ³ / ₈ " Seat Depth: 24" Top Size: 25 ¹ / ₄ " x 24"	120		5092	5443	6144	7195	8597

Leg + Frame Finish	Price
Chrome	\$ 165
Nickel	\$ 223
Powder Coat - Standard	n/c
Powder Coat - Premium	\$ 165

TRANSPARENT POWDER COAT NOT AVAILABLE

Power + Charging Options
See page 20 for power and charging options.

Custom Charges	Code	Price
Powder Coat Alternative (per color)	OPA	call
Stain Finish Match (per finish)	OSM	\$ 996

Questions?

1.800.876.2120



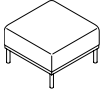

				material > grade >	Fabric Grade 2 or COM	Fabric Grade 3	Fabric Grade 4	Fabric Grade 5	Fabric Grade 6
Model #	Description	Dimensions	Product Wt						
CW2424	Ottoman Seat - Upholstered	Overall Height: 17½" Overall Width: 24" Overall Depth: 24"	35	1711	1852	2132	2553	3113	



To Order, Specify...

- 1 Model Number
- 2 Leg + Frame Color
- 3 Seat Upholstery
- 4 Top Material
 - a. Laminate manufacturer + color
 - b. Veneer species + finish color
- 5 Additional Options

Questions?
1.800.876.2120

				top > edge >	Laminate Self Edge	Veneer Self Edge
						
				LL9	VV9	
Model #	Description	Dimensions	Product Wt			
 CW1223RE	Rectangle	Width: 12" Depth: 23" Height 6" Mounted Height: 15½"	19	1291	2245	
 CW30D18WG	30° Wedge	Width: 17⅞" Depth: 22¼" Height 6" Mounted Height: 15½"	19	1487	2418	

Leg + Frame Finish	Price
Chrome	\$ 165
Nickel	\$ 223
Powder Coat - Standard	n/c
Powder Coat - Premium	\$ 165

TRANSPARENT POWDER COAT NOT AVAILABLE

Custom Charges	Code	Price
Powder Coat Alternative (per color)	OPA	call
Stain Finish Match (per finish)	OSM	\$ 996

All prices are delivered list price effective with date printed on cover and supersedes all other published price lists. Versteel reserves the right to change prices or specifications without prior notice. Orders are accepted subject to price prevailing at time of shipment.

versteel.com
Made in America
800 876 2120